

LECTURE NOTES

ON

SUB: INTERNAL COMBUSTION ENGINE & GAS TURBINES

**8th SEMESTER, B.TECH MECHANICAL ENGINEERING
COURSE CODE – BME 423**

Prepared by:

Mrs. Dulari Hansdah
Assistant Professor



**DEPARTMENT OF MECHANICAL ENGINEERING
VEER SURENDRA SAI UNIVERSITY OF
TECHNOLOGY, BURLA, ODISHA**

DISCLAIMER

This document does not claim any originality and cannot be used as a substitute for prescribed text books. The information presented here is merely a collection by the committee members for their respective teaching assignments. Various sources as mentioned at the reference of the document as well as freely available material from internet were consulted for preparing this document. The ownership of the information lies with the respective authors or institutions. Further, this document is not intended to be used for commercial purpose and the committee members are not accountable for any issues, legal or otherwise, arising out of use of this document. The committee members make no representations or warranties with respect to the accuracy or completeness of the contents of this document and specifically disclaim any implied warranties of merchantability or fitness for a particular purpose. The committee members shall be liable for any loss of profit or any other commercial damages, including but not limited to special, incidental, consequential, or other damages.

SYLLABUS

Module - I

1. Introduction: Classification of IC engines, working cycles, comparison of two stroke & four stroke engines, Comparison between SI & CI engines. (2)
2. Fuel combustion & Fuel injection: Structure & composition of IC engine fuel, Fuel rating properties of fuel, Fuel additives and non-petroleum fuels. Fuel air requirement for ideal normal operation, maximum power & quick acceleration, simple carburetor & its draw back. Practical carburetor, petrol injection. Requirements & type of diesel injection system, fuel pump, injectors & nozzles. (8)

Module - II

3. Ignition & combustion in IC Engines: Battery, magneto & Electronic ignition systems, Ignition timing, spark advance mechanism. Stages of SI engine combustion, Effect of engine variables on ignition lag flame front propagation. Abnormal combustion, pre-ignition & detonation, Theory of detonation, Effect of engine variables on detonation, Control of detonation. Requirement of good combustion chambers for SI engines. Stages of CI engine combustion. Effect of engine variables on delay periods. Diesel Knock & methods of control in CI engine combustion chambers. (10)

Module - III

4. Testing and performance: Power, Fuel and air measurement methods, performance of SI and CI Engines, Characteristics curve. Variables affecting performance and methods to improve engine performance. (5)
5. Cooling and Lubricating Systems, Engine Emission & Controls: Air cooling and Water cooling system, Effect of cooling on power output & efficiency, properties of lubricants & types of lubricating system engine emission & its harmful effect. Methods of measuring pollutants and control of engine emission. (7)

Module – IV

6. Gas turbines: Introduction, open & closed cycle gas turbines, Constant volume & constant pressure cycles. Thermodynamic analysis of ideal basic cycle with regeneration reheat & intercooling. Analysis of ideal basic cycle considering actual losses. Application of gas turbine. (8)

LESSON PLAN

Sl. No.	Lecture No.	Topics to be covered
1	Lecture-01	What is IC engines and components of IC engine, IC engine terminology, classification of IC engines, comparison of Two stroke & four stroke engines, Comparison between SI & CI engines, valve and port timing diagram
2	Lecture-02	Working cycles-Otto, Diesel and Dual cycle, problem solving
3	Lecture-03	Fuel- structure & composition of IC engine fuel, properties of SI and CI engine fuel, fuel rating
4	Lecture-04	Fuel additives and non-petroleum fuels (alternative fuels)
5	Lecture-05	Fuel air requirement for ideal normal operation, maximum power & quick acceleration, simple carburettor and its parts, problem solving
6	Lecture-06	Drawback of simple carburettor, types of carburettor
7	Lecture-07	Petrol injection, Lucas petrol injection system, electronic petrol injection system
8	Lecture-08	Requirements & type of diesel injection system
9	Lecture-09	fuel pump, types of injectors
10	Lecture-10	Types of nozzles, spray formation and its direction, injection timing
11	Lecture-11	Ignition system- requirements of ignition system, Battery and magneto ignition system
12	Lecture-12	Ignition timing, spark plug, spark advance mechanism
13	Lecture-13	Disadvantage of conventional ignition system, electronic ignition system
14	Lecture-14	Factors affecting energy requirement of ignition system
15	Lecture-15	Stages of SI engine combustion, effect of engine variables on ignition lag flame front propagation
16	Lecture-16	Abnormal combustion, pre-ignition & detonation, theory of detonation, effect of engine variables on detonation
17	Lecture-17	Control of detonation, requirement of good combustion chambers for SI engines
18	Lecture-18	Stages of CI engine combustion, effect of engine variables on delay periods
19	Lecture-19	Diesel Knock & methods of control in CI
20	Lecture-20	Diesel engine combustion chambers
21	Lecture-21	Testing and performance- Indicated power (indicator diagram-piston indicator, balanced-diaphragm type of indicator)
22	Lecture-22	Measurement of brake power (prony brake, rope brake, eddy current, hydraulic dynamometer), Measurement of friction power (Willian's line method, Morse test, Motoring test)
23	Lecture-23	Fuel consumption measurements (volumetric and gravimetric method), air consumption measurements
24	Lecture-24	Variables affecting performance of SI engine
25	Lecture-25	Variables affecting performance of CI engine, problem solving
26	Lecture-26	Engine emissions, measurement method of smoke emission, measurement of unburnt hydrocarbon emission

27	Lecture 27	Measurement of CO ₂ , NO _x , engine emission control
28	Lecture 28	Requirement of cooling of the engine, types of cooling, air cooling system
29	Lecture 29	Water cooling (thermo-syphon, forced or pump, evaporative cooling system)
30	Lecture 30	Comparison of cooling system, Effect of cooling on power output & efficiency
31	Lecture 31	Lubrication- requirement of lubrication of the engine, effect of variables on engine friction, principle and function of lubricating system, properties of lubricating oil
32	Lecture 32	Types of lubricating system, additives to lubricating oil
33	Lecture 33	Turbine definition, types of turbines, comparison of gas turbine with reciprocating IC engine and steam turbine, classification of gas turbine
34	Lecture-34	Thermodynamic cycle or Brayton cycle, problem solving
35	Lecture 35	Regenerative gas turbine cycle, reheat gas turbine cycle, problem solving
36	Lecture 36	Gas turbine cycle with both reheat and heat exchange method, gas turbine with inter cooler, problem solving
37	Lecture 37	Real gas turbine, losses calculation, problem solving
38	Lecture 38	Linking components of turbine, combustion chamber
39	Lecture 39	Fuels for turbine, emission from turbine
40	Lecture 40	Application of gas turbine, automotive gas turbine

INTERNAL COMBUSTION ENGINE & GAS TURBINES

Module - I

INTRODUCTION

Heat engine:

A heat engine is a device which transforms the chemical energy of a fuel into thermal energy and uses this energy to produce mechanical work. It is classified into two types-

- (a) External combustion engine
- (b) Internal combustion engine

External combustion engine:

In this engine, the products of combustion of air and fuel transfer heat to a second fluid which is the working fluid of the cycle.

Examples:

*In the steam engine or a steam turbine plant, the heat of combustion is employed to generate steam which is used in a piston engine (reciprocating type engine) or a turbine (rotary type engine) for useful work.

*In a closed cycle gas turbine, the heat of combustion in an external furnace is transferred to gas, usually air which the working fluid of the cycle.

Internal combustion engine:

In this engine, the combustion of air and fuels take place inside the cylinder and are used as the direct motive force. It can be classified into the following types:

1. According to the basic engine design- (a) Reciprocating engine (Use of cylinder piston arrangement), (b) Rotary engine (Use of turbine)
2. According to the type of fuel used- (a) Petrol engine, (b) diesel engine, (c) gas engine (CNG, LPG), (d) Alcohol engine (ethanol, methanol etc)
3. According to the number of strokes per cycle- (a) Four stroke and (b) Two stroke engine
4. According to the method of igniting the fuel- (a) Spark ignition engine, (b) compression ignition engine and (c) hot spot ignition engine
5. According to the working cycle- (a) Otto cycle (constant volume cycle) engine, (b) diesel cycle (constant pressure cycle) engine, (c) dual combustion cycle (semi diesel cycle) engine.

6. According to the fuel supply and mixture preparation- (a) Carburetted type (fuel supplied through the carburettor), (b) Injection type (fuel injected into inlet ports or inlet manifold, fuel injected into the cylinder just before ignition).
7. According to the number of cylinder- (a) Single cylinder and (b) multi-cylinder engine
8. Method of cooling- water cooled or air cooled
9. Speed of the engine- Slow speed, medium speed and high speed engine
10. Cylinder arrangement-Vertical, horizontal, inline, V-type, radial, opposed cylinder or piston engines.
11. Valve or port design and location- Overhead (I head), side valve (L head); in two stroke engines: cross scavenging, loop scavenging, uniflow scavenging.
12. Method governing- Hit and miss governed engines, quantitatively governed engines and qualitatively governed engine
14. Application- Automotive engines for land transport, marine engines for propulsion of ships, aircraft engines for aircraft propulsion, industrial engines, prime movers for electrical generators.

Comparison between external combustion engine and internal combustion engine:

External combustion engine	Internal combustion engine
*Combustion of air-fuel is outside the engine cylinder (in a boiler)	* Combustion of air-fuel is inside the engine cylinder (in a boiler)
*The engines are running smoothly and silently due to outside combustion	* Very noisy operated engine
*Higher ratio of weight and bulk to output due to presence of auxiliary apparatus like boiler and condenser. Hence it is heavy and cumbersome.	* It is light and compact due to lower ratio of weight and bulk to output.
*Working pressure and temperature inside the engine cylinder is low; hence ordinary alloys are used for the manufacture of engine cylinder and its parts.	* Working pressure and temperature inside the engine cylinder is very much high; hence special alloys are used
*It can use cheaper fuels including solid fuels	*High grade fuels are used with proper filtration
*Lower efficiency about 15-20%	*Higher efficiency about 35-40%
* Higher requirement of water for dissipation of energy through cooling system	*Lesser requirement of water
*High starting torque	*IC engines are not self-starting

Main components of reciprocating IC engines:

Cylinder: It is the main part of the engine inside which piston reciprocates to and fro. It should have high strength to withstand high pressure above 50 bar and temperature above

2000 °C. The ordinary engine is made of cast iron and heavy duty engines are made of steel alloys or aluminum alloys. In the multi-cylinder engine, the cylinders are cast in one block known as cylinder block.

Cylinder head: The top end of the cylinder is covered by cylinder head over which inlet and exhaust valve, spark plug or injectors are mounted. A copper or asbestos gasket is provided between the engine cylinder and cylinder head to make an air tight joint.

Piston: Transmit the force exerted by the burning of charge to the connecting rod. Usually made of aluminium alloy which has good heat conducting property and greater strength at higher temperature.

Figure 1 shows the different components of IC engine.

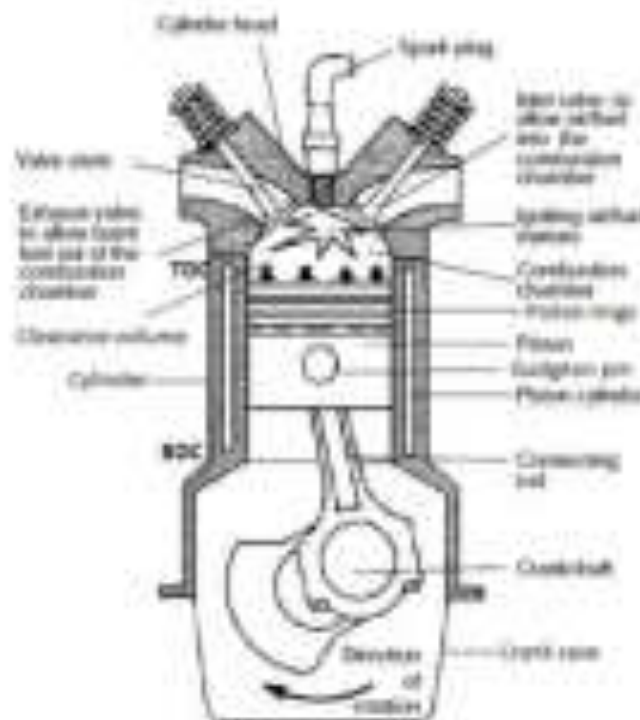

Fig. 1. Different parts of IC engine

Piston rings: These are housed in the circumferential grooves provided on the outer surface of the piston and made of steel alloys which retain elastic properties even at high temperature. 2 types of rings- compression and oil rings. Compression ring is upper ring of the piston which provides air tight seal to prevent leakage of the burnt gases into the lower portion. Oil ring is lower ring which provides effective seal to prevent leakage of the oil into the engine cylinder.

Connecting rod: It converts reciprocating motion of the piston into circular motion of the crank shaft, in the working stroke. The smaller end of the connecting rod is connected with the piston by gudgeon pin and bigger end of the connecting rod is connected with the crank

with crank pin. The special steel alloys or aluminium alloys are used for the manufacture of connecting rod.

Crankshaft: It converts the reciprocating motion of the piston into the rotary motion with the help of connecting rod. The special steel alloys are used for the manufacturing of the crankshaft. It consists of eccentric portion called crank.

Crank case: It houses cylinder and crankshaft of the IC engine and also serves as sump for the lubricating oil.

Flywheel: It is big wheel mounted on the crankshaft, whose function is to maintain its speed constant. It is done by storing excess energy during the power stroke, which is returned during other stroke.

Terminology used in IC engine:

1. Cylinder bore (D): The nominal inner diameter of the working cylinder.
2. Piston area (A): The area of circle of diameter equal to the cylinder bore.
3. Stroke (L): The nominal distance through which a working piston moves between two successive reversals of its direction of motion.
4. Dead centre: The position of the working piston and the moving parts which are mechanically connected to it at the moment when the direction of the piston motion is reversed (at either end point of the stroke).
 - (a) Bottom dead centre (BDC): Dead centre when the piston is nearest to the crankshaft.
 - (b) Top dead centre (TDC): Dead centre when the position is farthest from the crankshaft.
5. Displacement volume or swept volume (V_s): The nominal volume generated by the working piston when travelling from the one dead centre to next one and given as,

$$V_s = A \times L$$

6. Clearance volume (V_c): the nominal volume of the space on the combustion side of the piston at the top dead centre.

7. Cylinder volume (V): Total volume of the cylinder.

$$V = V_s + V_c$$

8. Compression ratio (r): $r = \frac{V_s}{V_c}$

Four stroke engine:

- Cycle of operation completed in four strokes of the piston or two revolution of the piston.

- (i) Suction stroke (suction valve open, exhaust valve closed)-charge consisting of fresh air mixed with the fuel is drawn into the cylinder due to the vacuum pressure created by the movement of the piston from TDC to BDC.
- (ii) Compression stroke (both valves closed)-fresh charge is compressed into clearance volume by the return stroke of the piston and ignited by the spark for combustion. Hence pressure and temperature is increased due to the combustion of fuel
- (iii) Expansion stroke (both valves closed)-high pressure of the burnt gases force the piston towards BDC and hence power is obtained at the crankshaft.
- (iv) Exhaust stroke (exhaust valve open, suction valve closed)- burned gases expel out due to the movement of piston from BDC to TDC.

Figure 2 show the cycle of operation of four stroke engine.

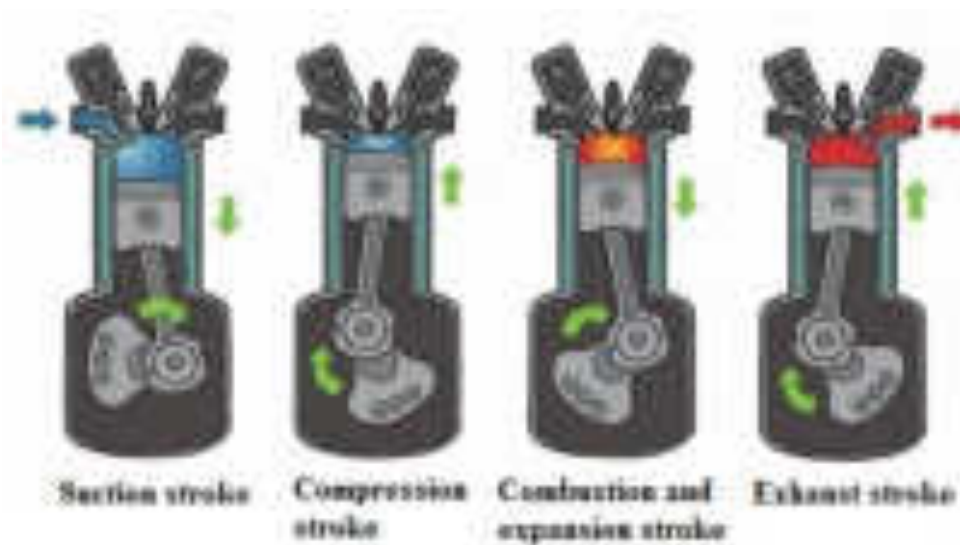

Fig. 2. Cycle of operation in four stroke engine

Two stroke engine:

- No piston stroke for suction and exhaust operations
- Suction is accomplished by air compressed in crankcase or by a blower
- Induction of compressed air removes the products of combustion through exhaust ports
- Transfer port is there to supply the fresh charge into combustion chamber

Figure 3 represents operation of two stroke engine

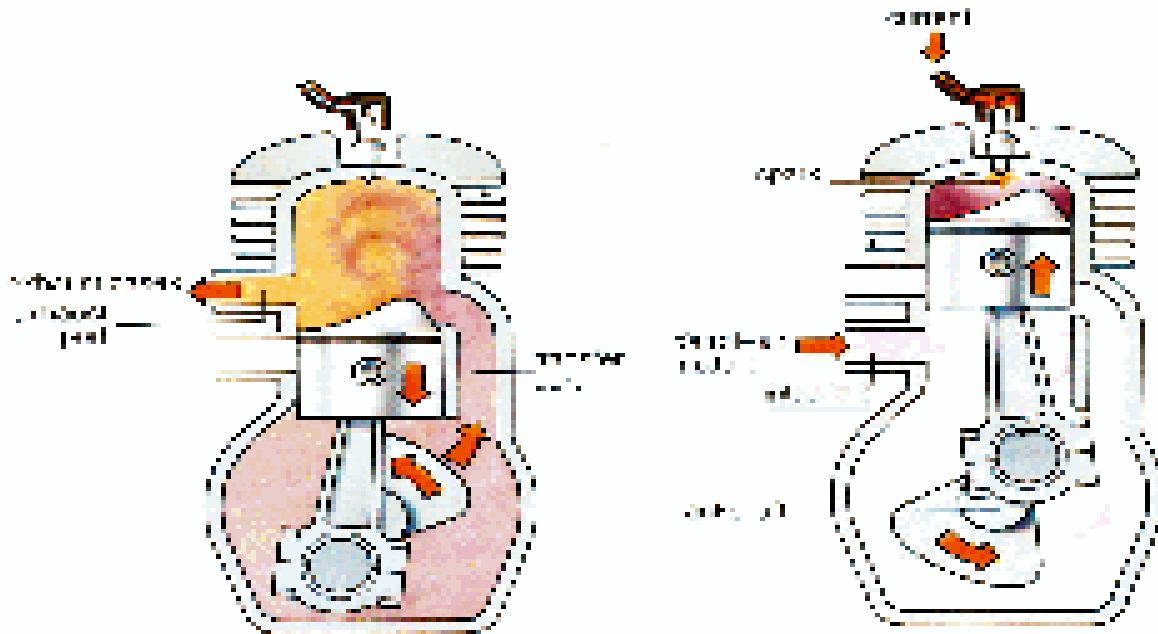

Fig. 3. Cycle of operation in two stroke engine

Comparison of Four-stroke and two-stroke engine:

Four-stroke engine	Two-stroke engine
1. Four stroke of the piston and two revolution of crankshaft	Two stroke of the piston and one revolution of crankshaft
2. One power stroke in every two revolution of crankshaft	One power stroke in each revolution of crankshaft
3. Heavier flywheel due to non-uniform turning movement	Lighter flywheel due to more uniform turning movement
4. Power produce is less	Theoretically power produce is twice than the four stroke engine for same size
5. Heavy and bulky	Light and compact
6. Lesser cooling and lubrication requirements	Greater cooling and lubrication requirements
7. Lesser rate of wear and tear	Higher rate of wear and tear
8. Contains valve and valve mechanism	Contains ports arrangement
9. Higher initial cost	Cheaper initial cost
10. Volumetric efficiency is more due to greater time of induction	Volumetric efficiency less due to lesser time of induction
11. Thermal efficiency is high and also part load efficiency better	Thermal efficiency is low, part load efficiency lesser
12. It is used where efficiency is important.	It is used where low cost, compactness and light weight are important.
Ex-cars, buses, trucks, tractors, industrial engines, aero planes, power generation etc.	Ex-lawn mowers, scooters, motor cycles, mopeds, propulsion ship etc.

Comparison of SI and CI engine:

SI engine	CI engine
Working cycle is Otto cycle.	Working cycle is diesel cycle.
Petrol or gasoline or high octane fuel is used.	Diesel or high cetane fuel is used.
High self-ignition temperature.	Low self-ignition temperature.
Fuel and air introduced as a gaseous mixture in the suction stroke.	Fuel is injected directly into the combustion chamber at high pressure at the end of compression stroke.
Carburettor used to provide the mixture. Throttle controls the quantity of mixture introduced.	Injector and high pressure pump used to supply of fuel. Quantity of fuel regulated in pump.
Use of spark plug for ignition system	Self-ignition by the compression of air which increased the temperature required for combustion
Compression ratio is 6 to 10.5	Compression ratio is 14 to 22
Higher maximum RPM due to lower weight	Lower maximum RPM
Maximum efficiency lower due to lower compression ratio	Higher maximum efficiency due to higher compression ratio
Lighter	Heavier due to higher pressures

Valve timing diagram:

The exact moment at which the inlet and outlet valve opens and closes with reference to the position of the piston and crank shown diagrammatically is known as valve timing diagram. It is expressed in terms of degree crank angle. The theoretical valve timing diagram is shown in Fig. 4.

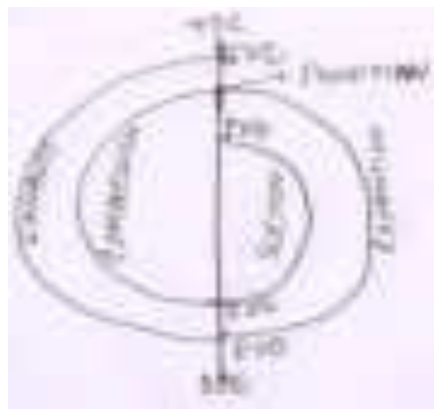

Fig. 4. Theoretical valve timing diagram

But actual valve timing diagram is different from theoretical due to two factors-mechanical and dynamic factors. Figure 4 shows the actual valve timing diagram for four stroke low speed or high speed engine.

Opening and closing of inlet valve

-Inlet valve opens 12 to 30° CA before TDC to facilitate silent operation of the engine under high speed. It increases the volumetric efficiency.

-Inlet valve closes 10-60° CA after TDC due to inertia movement of fresh charge into cylinder i.e. ram effect.

Figure 5 represents the actual valve timing diagram for low and high speed engine.

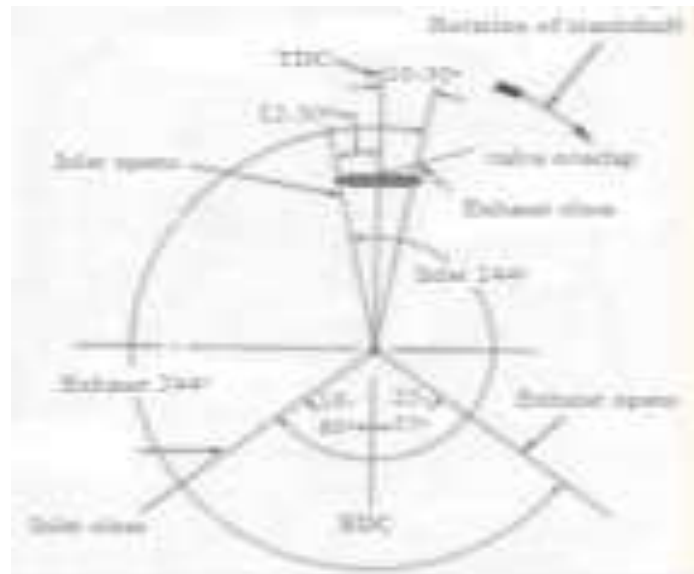

Fig. 5. Actual valve timing diagram for low and high speed engine

Opening and closing of exhaust valve

Exhaust valve opens 25 to 55° CA before BDC to reduce the work required to expel out the burnt gases from the cylinder. At the end of expansion stroke, the pressure inside the chamber is high, hence work to expel out the gases increases.

Exhaust valve closes 10 to 30° CA after TDC to avoid the compression of burnt gases in next cycle. Kinetic energy of the burnt gas can assist maximum exhausting of the gas. It also increases the volumetric efficiency.

Note: For low and high speed engine, the lower and upper values are used respectively

Valve overlap

During this time both the intake and exhaust valves are open. The intake valve is opened before the exhaust gases have completely left the cylinder, and their considerable velocity assists in drawing in the fresh charge. Engine designers aim to close the exhaust valve just as the fresh charge from the intake valve reaches it, to prevent either loss of fresh charge or unscavenged exhaust gas.

Port timing diagram:

- Drawn for 2-stroke engine
- No valve arrangement
- 3 ports- inlet, transfer and exhaust

Figure 6 shows port timing diagram for 2-stroke engine

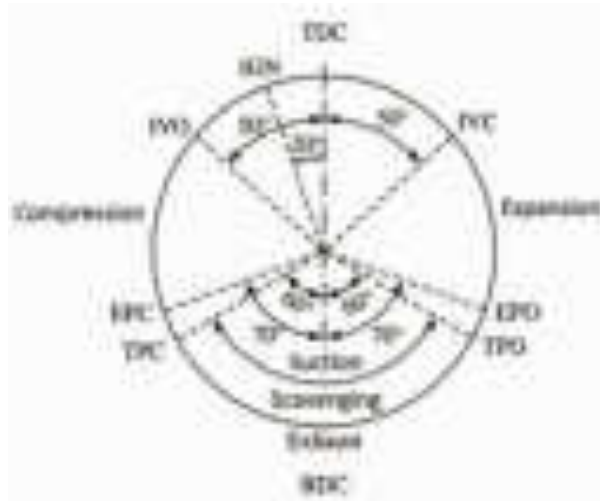

Fig. 6. Port timing diagram for 2-stroke engine

Working cycle:

- (a) **Otto cycle-** thermodynamic cycle for SI/petrol engine
 - Reversible adiabatic compression and expansion process
 - Constant volume heat addition (combustion) and heat rejection process (exhaust)
- Figure 7 depicts the Otto cycle

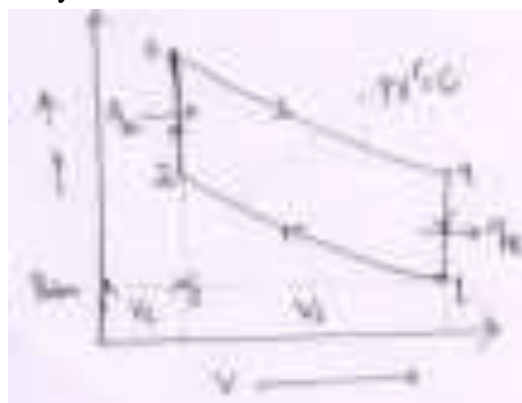

Fig. 7. Otto cycle

Heat supplied, $q_s = C_v(T_3 - T_2)$

Heat rejection, $q_R = C_v(T_4 - T_1)$

Compression ratio, $r_k = \frac{V_1}{V_2}$

Thermal efficiency, $\eta_{th} = \frac{q_s - q_R}{q_s} = \frac{C_v(T_3 - T_2) - C_v(T_4 - T_1)}{C_v(T_3 - T_2)} = 1 - \frac{T_4 - T_1}{T_3 - T_2}$

In process 1-2, adiabatic compression process,

$$\frac{T_2}{T_1} = \left(\frac{V_1}{V_2}\right)^{\gamma-1}$$

$$\Rightarrow T_2 = T_1 \cdot (r_k)^{\gamma-1}$$

In adiabatic expansion process, i.e. 3-4,

$$\frac{T_4}{T_3} = \left(\frac{V_3}{V_4}\right)^{\gamma-1} = \left(\frac{V_2}{V_1}\right)^{\gamma-1}$$

$$\Rightarrow T_3 = T_4 \cdot (r_k)^{\gamma-1}$$

$$\begin{aligned} \eta_{th} &= 1 - \frac{T_4 - T_1}{T_4 \cdot (r_k)^{\gamma-1} - T_1 \cdot (r_k)^{\gamma-1}} \\ &= 1 - \frac{1}{(r_k)^{\gamma-1}} \end{aligned}$$

Work done (W)

$$\text{Pressure ratio, } r_p = \frac{P_3}{P_2} = \frac{P_4}{P_1}$$

$$\frac{P_2}{P_1} = \frac{P_3}{P_4} = \left(\frac{V_1}{V_2}\right)^{\gamma} = (r_k)^{\gamma}$$

$$\begin{aligned} W &= \frac{P_3 V_3 - P_4 V_4}{\gamma - 1} - \frac{P_2 V_2 - P_1 V_1}{\gamma - 1} \\ &= \frac{1}{\gamma - 1} \left[P_4 V_4 \left(\frac{P_3 V_3}{P_4 V_4} - 1 \right) - P_1 V_1 \left(\frac{P_2 V_2}{P_1 V_1} - 1 \right) \right] \\ &= \frac{1}{\gamma - 1} [P_4 V_1 (r_k^{\gamma-1} - 1) - P_1 V_1 (r_k^{\gamma-1} - 1)] \\ &= \frac{P_1 V_1}{\gamma - 1} [r_p (r_k^{\gamma-1} - 1) - (r_k^{\gamma-1} - 1)] \\ &= \frac{P_1 V_1}{\gamma - 1} [(r_k^{\gamma-1} - 1)(r_p - 1)] \end{aligned}$$

$$\text{Mean effective pressure, } P_m = \frac{\text{work done}}{\text{swept volume}} = \frac{\text{work done}}{V_1 - V_2}$$

$$P_m = \frac{\frac{P_1 V_1}{\gamma - 1} [(r_k^{\gamma-1} - 1)(r_p - 1)]}{V_1 - V_2} = \frac{P_1 r_k [(r_k^{\gamma-1} - 1)(r_p - 1)]}{(\gamma - 1)(r_k - 1)}$$

(b) **Diesel cycle**- thermodynamic cycle for low speed CI/diesel engine

-Reversible adiabatic compression and expansion process

-Constant pressure heat addition (combustion) and heat rejection process (exhaust)

Figure 8 depicts the diesel cycle.

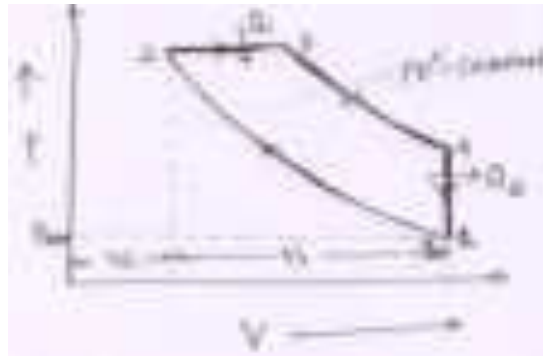

Fig. 8. Diesel cycle

Heat supplied, $Q_1 = C_p(T_3 - T_2)$

Heat rejection, $Q_2 = C_v(T_4 - T_1)$

Compression ratio, $r_k = \frac{V_1}{V_2}$

Cut off ratio, $r_c = \frac{V_3}{V_2}$

Thermal efficiency, $\eta_{th} = \frac{Q_1 - Q_2}{Q_1} = \frac{C_p(T_3 - T_2) - C_v(T_4 - T_1)}{C_p(T_3 - T_2)} = 1 - \frac{1}{\gamma} \frac{(T_4 - T_1)}{(T_3 - T_2)}$

In adiabatic compression process i.e. 1-2,

$$\frac{T_2}{T_1} = \left(\frac{V_1}{V_2}\right)^{\gamma-1}$$

$$\Rightarrow T_2 = T_1 \cdot (r_k)^{\gamma-1}$$

In process 2-3, pressure constant, then

$$\frac{T_3}{T_2} = \frac{V_3}{V_2} = r_c$$

$$\Rightarrow T_3 = T_2 \cdot r_c = T_1 \cdot (r_k)^{\gamma-1} \cdot r_c$$

In adiabatic expansion process i.e. 3-4,

$$\frac{T_4}{T_3} = \left(\frac{V_3}{V_4}\right)^{\gamma-1} = \left(\frac{V_3}{V_2} \cdot \frac{V_2}{V_4}\right)^{\gamma-1} = (r_c)^{\gamma-1} \cdot \frac{1}{(r_k)^{\gamma-1}}$$

$$\Rightarrow T_4 = T_3 \cdot (r_c)^{\gamma-1} \cdot \frac{1}{(r_k)^{\gamma-1}} = T_1 \cdot (r_k)^{\gamma-1} \cdot r_c \cdot (r_c)^{\gamma-1} \cdot \frac{1}{(r_k)^{\gamma-1}} = T_1 \cdot r_c$$

$$\eta_{th} = 1 - \frac{1}{\gamma} \frac{(T_4 - T_1)}{(T_3 - T_2)} = 1 - \frac{1}{\gamma \cdot (r_k)^{\gamma-1}} \left[\frac{(r_c)^\gamma - 1}{r_c - 1} \right]$$

Work done (W)

$$W = P_2(V_3 - V_2) + \frac{P_3 V_3 - P_4 V_4}{\gamma - 1} - \frac{P_2 V_2 - P_1 V_1}{\gamma - 1}$$

$$= P_2(r_c V_2 - V_2) + \frac{P_2 r_c V_2 - P_4 r_k V_2}{\gamma - 1} - \frac{P_2 V_2 - P_1 r_k V_2}{\gamma - 1}$$

since $V_4 = V_1$

$$= P_2 V_2 \left[\frac{(r_c - 1)(\gamma - 1) + (r_c - r_c^\gamma \cdot r_k^{-\gamma} \cdot r_k) - (1 - r_k^{1-\gamma})}{\gamma - 1} \right]$$

$$= P_1 V_1 \cdot r_k^{\gamma-1} \left[\frac{\gamma(r_c - 1) - r_k^{1-\gamma}(r_c^\gamma - 1)}{\gamma - 1} \right]$$

Mean effective pressure,

$$P_m = \frac{P_1 V_1 r_k^{\gamma-1} \left[\frac{\gamma(r_c-1) - r_k^{1-\gamma} (r_c^{\gamma-1})}{\gamma-1} \right]}{V_1 - V_2} = \frac{P_1 r_k^{\gamma} [\gamma(r_c-1) - r_k^{1-\gamma} (r_c^{\gamma-1})]}{(\gamma-1)(r_k-1)}$$

(c) Dual cycle or limited pressure cycle-thermodynamic cycle for high speed diesel and hot spot ignition engine

- Reversible adiabatic compression and expansion process
- Constant pressure and constant volume heat addition (combustion) and heat rejection process

Total heat supplied, $Q_1 = C_v(T_3 - T_2) + C_p(T_4 - T_3)$

Heat rejection, $Q_2 = C_v(T_5 - T_1)$

Compression ratio, $r_k = \frac{V_1}{V_2}$

Cut off ratio, $r_c = \frac{V_4}{V_3}$

Pressure ratio, $r_p = \frac{P_3}{P_2}$

Figure 9 shows the P-V diagram of Dual cycle.

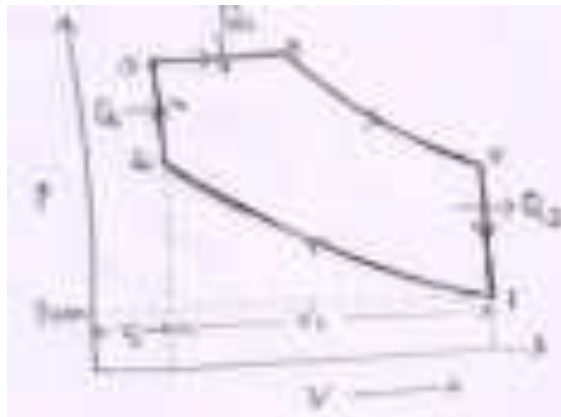

Fig. 9. Dual cycle

$$\text{Thermal efficiency, } \eta_{th} = \frac{Q_1 - Q_2}{Q_1} = \frac{C_v(T_3 - T_2) + C_p(T_4 - T_3) - C_v(T_5 - T_1)}{C_v(T_3 - T_2) + C_p(T_4 - T_3)} = 1 - \frac{(T_5 - T_1)}{(T_3 - T_2) + \gamma(T_4 - T_3)}$$

In adiabatic compression process i.e. 1-2,

$$\frac{T_2}{T_1} = \left(\frac{V_1}{V_2} \right)^{\gamma-1} = (r_k)^{\gamma-1}$$

In constant volume combustion process i.e. 2-3,

$$\frac{P_3}{P_2} = \frac{T_3}{T_2} = r_p$$

$$\Rightarrow T_2 = \frac{T_3}{r_p}$$

In constant pressure combustion process i.e. 3-4,

$$\frac{V_3}{V_4} = \frac{T_3}{T_4}$$

$$\Rightarrow T_4 = T_3 \cdot r_c$$

In adiabatic expansion process i.e. 4-5,

$$\frac{T_4}{T_5} = \left(\frac{V_5}{V_4}\right)^{\gamma-1} = \left(\frac{V_1}{V_4}\right)^{\gamma-1} = \left(\frac{r_k}{r_c}\right)^{\gamma-1}$$

$$\Rightarrow T_5 = r_c \cdot T_3 \cdot \left(\frac{r_c}{r_k}\right)^{\gamma-1}$$

$$\eta_{th} = 1 - \frac{(T_5 - T_1)}{(T_3 - T_2) + \gamma(T_4 - T_3)} = 1 - \frac{1}{(r_k)^{\gamma-1}} \left[\frac{r_p \cdot (r_c)^{\gamma-1}}{(r_p - 1) + \gamma r_p (r_c - 1)} \right]$$

Work done (W)

$$\begin{aligned} W &= P_3(V_4 - V_3) + \frac{P_4 V_4 - P_5 V_5}{\gamma - 1} - \frac{P_2 V_2 - P_1 V_1}{\gamma - 1} \\ &= P_3 V_3 (r_c - 1) + \frac{(P_4 r_c V_3 - P_5 r_k V_3) - (P_2 V_3 - P_1 r_k V_3)}{\gamma - 1} \\ &= \frac{P_1 V_1 \cdot r_k^{\gamma-1} [\gamma r_p (r_c - 1) + (r_p - 1) - r_k^{\gamma-1} (r_p r_c^\gamma - 1)]}{\gamma - 1} \end{aligned}$$

Mean effective pressure,

$$\begin{aligned} P_m &= \frac{\frac{P_1 V_1 \cdot r_k^{\gamma-1} [\gamma r_p (r_c - 1) + (r_p - 1) - r_k^{\gamma-1} (r_p r_c^\gamma - 1)]}{\gamma - 1}}{V_1 - V_2} \\ &= \frac{P_1 r_k^\gamma [r_p (r_c - 1) + (r_p - 1) - r_k^{1-\gamma} (r_p r_c^\gamma - 1)]}{(\gamma - 1)(r_k - 1)} \end{aligned}$$

Comparison of Otto, Diesel and Dual cycle:

(a) For same compression ratio and same heat input

$$(\eta_{th})_{Otto} > (\eta_{th})_{Dual} > (\eta_{th})_{Diesel}$$

(b) For constant maximum pressure and same heat input

$$(\eta_{th})_{Diesel} > (\eta_{th})_{Dual} > (\eta_{th})_{Otto}$$

(c) For same maximum pressure and temperature

$$(\eta_{th})_{Diesel} > (\eta_{th})_{Dual} > (\eta_{th})_{Otto}$$

(d) For same maximum pressure and output

$$(\eta_{th})_{Diesel} > (\eta_{th})_{Otto}$$

FUELS & FUEL INJECTION

In IC engines, the chemical energy contained in the fuel is converted into mechanical power by burning (oxidizing) the fuel inside the combustion chamber of the engine.

Fuels suitable for fast chemical reaction have to be used in IC engines, they are following types-

(a) Hydrocarbons fuels derived from the crude petroleum by proper refining process such as thermal and catalytic cracking method, polymerisation, alkylation, isomerisation, reforming and blending.

(b) Alternative fuels such as-Alcohols (methanol, ethanol)

Natural gas (methane)

LPG (propane, butane)

Hydrogen

***Classification of petroleum fuels used for IC engine:**

Liquid hydrocarbons- Engine fuels are mainly mixtures of hydrocarbons, with bonds between hydrogen and carbon atoms. During combustion these bonds are broken and new bonds are formed with oxygen atoms, accompanied by the release of chemical energy. Principal products are carbon dioxide and water vapour. Fuels also contain small amounts of S, O₂, N₂, H₂O. The different constituents of crude petroleum which are available in liquid hydrocarbons are- paraffins, naphthenes, naphthenes, olefins, aromatics.

(i) Paraffin-

-Paraffins or alkanes can in general be represented by-C_nH_{2n+2}

-All the carbon bonds are single bonds – they are “saturated” high number of H atoms, high heat content and low density (620 – 770 kg/m³)

-The carbon atoms can be arranged as a straight chain or as branched chain compounds.

-Straight chain group (normal paraffins)

- shorter the chain, stronger the bond
- not suitable for SI engines – high tendency for autoignition according to the value of “n” in the formula, they are in gaseous (1 to 4), liquid (5 to 15) or solid (>16) state.

-Hexan C_6H_{14} (normal paraffin)

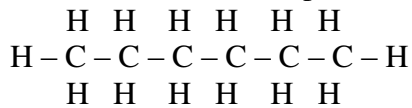

- Branched chain compounds (isoparaffins)

When four or more C atoms are in a chain molecule it is possible to form isomers, they have the same chemical formula but different structures, which often leads to very different chemical properties.

Example: Iso-octane- C_8H_{18}

(ii) Naphthenes-

-Also called as cycloparaffins and represented as C_nH_{2n}

-Saturated hydrocarbons which are arranged in a circle have stable structure and low tendency to autoignite compared to alkanes (normal paraffins)

-Can be used both in SI-engines and CI-engines

-Low heat content and high density (740 – 790 kg / m³)

(iii) Olefins-

-Olefins or alkenes are represented as Mono olefins- C_nH_{2n} or Dio-olefins C_nH_{2n-2}

-Olefins have the same C-to-H ratio and the same general formula as naphthenes, their behavior and characteristics are entirely different

-They are straight or branch chain compounds with one or more double bond. The position of the double bond is indicated by the number of first C atom to which it is attached, i.e.,

$CH_2=CH.CH_2.CH_2.CH_3$ called pentene-1

$CH_3.CH=CH_3$ called butene-2

-Olefinic compounds are easily oxidized, have poor oxidation stability

-Can be used in SI-engines, obtained by cracking of large molecules low heat content and density in the range 620 – 820 kg / m³

Alkenes are such as,

Hexen (mono-olefin)

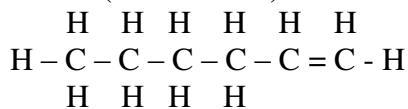

Butadien (dio-olefin)

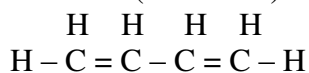

(iv) Aromatics-

-These are so called due to aromatics odour and represented as C_nH_{2n-6}

-They are based on a six-membered ring having three conjugated double bonds

-Aromatic rings can be fused together to give polynuclear aromatics, PAN, also called polycyclic aromatic hydrocarbons, PAH simplest member is benzene (C_6H_6)

- Can be used in SI-engines, to increase the resistance to knock not suitable for CI-engines due to low cetene number
- Low heat content and high density in the range 800 – 850 kg / m³

***Refinery processes:**

Crude oil is the liquid part of the naturally occurring organic material composed mostly of HCs that is trapped geologically in underground reservoirs – it is not uniform and varies in density, chemical composition, boiling range etc. for different fields. The refinery processes involved in production of different range of fuel is shown in Fig. 10 and Fig. 11.

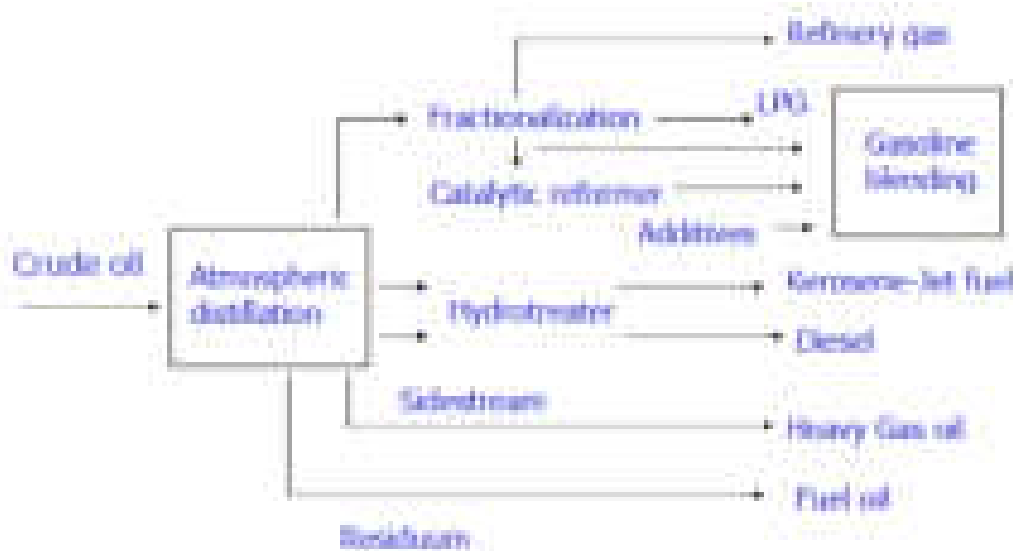

Fig. 10. Refinery processes

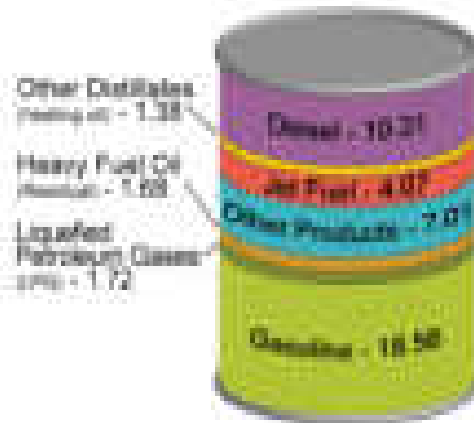

Fig. 11. Products made from crude oil

(i) Distillation process

- This is the initial process used in all refineries – aims to separate the crude oil into different boiling range fractions, each of which may be a product in its own right, a blend component or feed for further processing step
- Crude oil contains many thousands of different HCs, each has its own boiling point – lightest are gases at ambient temperature but can remain dissolved in heavier liquid HCs unless

temperature is raised, heaviest are solids at ambient temperature but stay in solution unless temperature is lowered.

Gasoline distillation temperature is 35 – 200 °C

Jet fuel 35 - 150

Diesel fuel 175 – 370

Heavy fuels, oil 370 – 550

-Generally distillation of crude oil produces 30% gasoline, 20-40 % diesel fuel, 20 % heavy fuels, 10-20 % heavy oils.

(ii) Cracking process

-There are two types of cracking process for engine fuel production: thermal cracking and catalytic cracking

(a)Thermal cracking: It takes place through the creation of HC free radicals by C to- C bond scission

-The feed is heated to around 500 - 600 °C and 70 - 100 bars and passed into a soaking chamber where cracking takes place. The cracked products are fractionated. The product is relatively unstable and requires the use of antioxidants and other treatments to prevent gum formation in use. It has relatively poor MON (motor octane number).

(b)Catalytic cracking: It is the most important and widely used process for converting heavy refinery streams to lighter products – to increase the ratio of light to heavy products from crude oil.

-Compared to thermal cracking, it has higher yield, improved quality product for gasoline (not for diesel fuel) and superior economics.

-A fluidized bed of catalyst is used – feed is introduced into it. Catalyst flows from one vessel to another through a pipe (between reactor and regenerator). Cracked oil vapour pass to fractionating towers where smaller molecules are separated from heavier products (gas, catalytic naphtha, cycle oils and residue).

-Aluminium silicate known as zeolite is used as a catalyst – has high activity and suppress the formation of light olefins.

(iii)Alkylation: It is a process for producing a high-octane gasoline component (alkylate) by combining light olefins with isobutane in the presence of a strongly acidic catalyst (sulfuric or hydrofluoric acid).

(iv)Isomerization: It is a process for converting straight chain paraffins to branch chain – used to provide isobutane feed for the alkylation process or to convert relatively low-octane quality of straight paraffins to more valuable branch chain molecules.

eg. n-pentane with RON (research octane number) 62 can be converted to isopentane with RON 92

-Process involves contacting HCs with a catalyst (platinum on a zeolite base) and separating any unchanged straight paraffins for recycle through the unit. The product is clean burning and has better RON quality.

(v) Polymerization: It is a process where light olefins such as propene and butenes are reacted together to give heavier olefins which have good octane quality and low vapour pressure in gasoline.

-Most commonly used catalyst is phosphoric acid

-The product is almost 100 % olefinic and has relatively poor MON compared with RON.

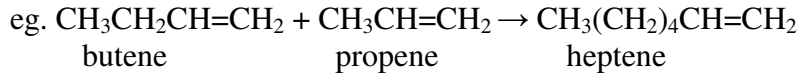

***Alternative fuels:**

(a) Alcohols: These include methanol (methyl alcohol), ethanol (ethyl alcohol), propanol (propyl alcohol), butanol (butyl alcohol) as compounds

-The OH group which replaces one of the H atoms in an alkane, gives these compounds their characteristic properties

-Specific heating value is lower than gasoline (42 – 43 MJ/kg)
methanol (19.7 MJ/kg) and ethanol (26.8 MJ/kg)

-For air-fuel mixture SHV is comparable with gasoline (MJ/kg-mixture at stoichiometric mixtures)

-Other alcohol groups such as dihydric and trihydric alcohols are not used as a fuel in IC engines

(i) Methanol

-Can be obtained from natural gas – has near and long-term potential

-Has high octane quality (130 RON, 95 MON)

-Can be used in low-concentration (5-15 %) in gasoline to increase octane number of the mixture

Problems;

-Poor solubility in gasoline, toxicity, low energy content (about half of gasoline), high latent heat of vaporization and oxygen content

-Contribute to poor driveability, incompatibility with some metals

(ii) Ethanol

-Produced from biomass

-It is made from the sugars found in grains, such as: Corn, Sorghum, and Barley

Other sources of sugars to produce ethanol include: Potato skins, Rice, Sugar cane, Sugar beets, Yard clippings, Bark, Switch grass etc.

-Has high octane number – can be used in low-concentrations in gasoline

-Most of the ethanol used in the United States today is distilled from corn

-Scientists are working on cheaper ways to make ethanol by using all parts of plants and trees rather than just the grain.

-About 99% of the ethanol produced in the United States is used to make "E10" or "gasohol," a mixture of 10% ethanol and 90% gasoline.

-Any gasoline powered engine can use E10, but only specially made vehicles can run on E85, a fuel that is 85% ethanol and 15% gasoline

(b) Biodiesel:

- It is methyl or ethyl ester of a fatty acid produced from vegetable oil of edible or non edible types or animal fat or algae, by transesterification process using catalysts.
- Has better lubricating properties and much higher cetane ratings than today's low sulfur diesel fuels.
- Its addition reduces the fuel system wear.
- Can be used in the pure form (B100), or may be blended with petroleum diesel in any concentration in most diesel engines for transportation purpose.
- But, the engine may face problems, such as low temperature operation, less durability and drop in power. New diesel fuel injection systems, such as common rail systems are equipped with materials that are compatible with biodiesel (B100).
- Biodiesel offers a substantial reduction in particulate matter (25%-50%) and a marginal increase of NO_x (1%-6% when it is used as an alternative fuel in a CI engine).
- The major problems associated with biodiesel are (i) poor oxidation stability, (ii) higher viscosity and density, (iii) lower calorific value, and (iv) cold flow property.
- Blends of 20% and lower biodiesel can be used in diesel engines with no, or only minor modifications.

(c) Biogas:

- Produced by the anaerobic decomposition of organic materials such as cow dung and other waste such as cornhusks, leaves, straw, garbage, flesh of car cusses, poultry droppings, pig dung, human excreta, sewage and the plants specially grown for this purpose like water hyacinth, algae, certain types of grasses. Also any cellulosic organic material of animal or plant origin which is easily bio-degradable is a potential raw material for biogas production. - Also produced by pyrolysis and hydrogasification methods
- Contains a mixture of methane (50-60% vol), CO₂ (30-45%), hydrogen (5-10%), nitrogen (0.5-7%) and small traces of other gases such as hydrogen sulphide and oxygen
- It is a clean, but slow burning gas and having value between 5000 to 5500 kcal/kg or 38131 kJ/m³
- The octane rating of biogas is 130 and ignition temperature is 650 °C
- Can be used to operate both compression ignition (diesel) and spark ignition (petrol) engines. CI engines can operate on dual-fuel (biogas+diesel) operation and pilot injection operation in which small quantity of diesel is required for igniting the mixture of air and biogas
- 80% saving of diesel oil can be achieved
- Drawback of biogas is present of CO₂. The engine performance can be improved by reducing the CO₂ content in biogas.

(d) Hydrogen:

- Clean burning fuel and has the highest energy content per unit mass of any chemical fuels which can reduce the dependency on hydrocarbon based fuels

Production:

Most common method of producing hydrogen involves splitting water (H₂O) into its component parts of hydrogen (H₂) and oxygen (O). There are different methods to produce hydrogen-

- i. Steam reformation or partial oxidation of hydrocarbons such as natural gas, naphtha or crude oil. It converts methane into hydrogen and carbon monoxide by reaction with steam over a nickel catalyst.
- ii. Coal gasification- Hydrogen made from coal can probably be justified as a fuel for special applications where the unique characteristics of hydrogen can be put to advantage such as its weight or its non-polluting characteristics.
- iii. Electrolysis- it uses electrical current to split water into hydrogen at the cathode (+) and oxygen at anode (-) [3].
- iv. Thermo chemical method- it utilizes heat to achieve the chemical splitting of water to its elements without the need for intermediate electricity generation and without the need to use the extremity high temperature of 2500 °C or more.
- v. Photo-electrolysis- it uses sunlight and catalysts to split water. In this method, a current is generated by exposing on or both electrodes to sunlight. Hydrogen and oxygen gases are liberated at the 2 electrodes by the decomposition of water. A catalyst may be included to facilitate the electrode process.
- vi. Biological and photo-biological water splitting use sunlight and biological organisms to split water.
- vii. Thermal water splitting uses a very high temperature (approximately 1000 °C) to split water.
- viii. Biomass gasification uses selected microbes to break down a variety of biomass feed stocks into hydrogen.

Utilization of hydrogen gas:

Hydrogen can be utilized for the following purpose:

- i. Residential use- hydrogen can be used in domestic cooking (stoves), radiant space heaters, electricity for lighting and for operating domestic appliances (e.g. refrigerator) which could be generated by means of fuel cells, with hydrogen gas at one electrode and air at other.
- ii. Industrial use- hydrogen can be used as a fuel or a chemical reducing (i.e. oxygen removal) agent. It can also be used instead of coal or coal derived gases, to reduce oxide ores (iron ore) to the material (iron).
- iii. Air craft application- The earliest application of liquid hydrogen fuel is expected to be in a jet air craft. Cold liquid hydrogen can be used directly or indirectly to cool the engine and the air frame surfaces of a high speed air craft.
- iv. Electric power generation- It comprises the production of electricity by using hydrogen in fuel cell system. Hydrogen could also be used as a means for storing and distributing electrical energy. The objective of developing fuel cell power stations is to centralized and local generation of electricity.
- v. As an alternative transport fuel- Hydrogen is tried as an alternative fuel in internal combustion engine. The stoichiometric hydrogen air mixture burns seven times as fast as the corresponding gasoline air mixture which is a great advantage in internal

combustion engines, leading to higher engine speeds and greater thermal efficiency [2]. Hydrogen fuel used in IC engines is in automobiles, buses, trucks and farm machinery.

Methods of using Hydrogen as a fuel in CI engines

- i. A mixture of fuel gas and air, with an approximately constant fuel to air ratio is introduced into the cylinder intake manifold. The engine power is controlled by varying the quantity of mixture entering the cylinder by means of throttle valve. It is not safe because the mixture is formed in the manifold.
- ii. The hydrogen is injected directly into the engine cylinder through a valve under pressure and air is inducted through another intake valve. This method is safer one, since hydrogen and air are supplied separately; an explosive mixture is occurred inside the cylinder only. The engine power output is controlled by varying the pressure of hydrogen gas from about 14 atm at low power to 70 atm at high power.
- iii. During the intake stroke, the hydrogen gas at normal or moderate pressure is drawn through the throttle valve into the engine cylinder whereas unthrottled air is drawn in through the intake port. The variation of engine power can be achieved with adjustment of hydrogen inlet throttle. The changes in fuel proportion as well as power is developed due to supply of un throttle air and power variation is possible because of the wide composition range over which hydrogen-air mixture can be ignited [1].

Advantages of using Hydrogen fuelled engine

- i. It provides high efficiency because it utilizes a higher proportion of the energy in the fuel.
- ii. The amount of carbon monoxide and hydrocarbons in the exhaust is very small since they are originating only from the cylinder lubricating oil.
- iii. It can be easily available because it is produced by electrolysis of water.
- iv. Fuel leakage to environment is not pollutant.

Disadvantages of using Hydrogen fuelled engine

- i. Due to high heat release the combustion temperature may be high and also a level of nitrogen oxide is high. It can be reduced by reducing the combustion temperature by injecting water vapor into the cylinder from the exhaust.
- ii. It requires heavy, bulky fuel storage both in vehicle and at the service station.
- iii. Difficulty in refueling and possibility of detonation.
- iv. Poor engine volumetric efficiency- gaseous fuel will displace some of inlet air and poor volumetric efficiency will result.
- v. Fuel cost would be high at present day technology [2].

(e) Natural Gas:

-Natural gas is present in the earth and is often produced in association with the production of crude oil. Processing is required to separate the gas from petroleum liquids and to remove contaminants. First, the gas is separated from free liquids such as crude oil, hydrocarbon condensate, water and entrained solids. The separated gas is further processed to meet certain pipelines quality specifications with respect to water content, hydrocarbon dew point, heating value and hydrogen sulphide content. Generally, a gas sweetening plant removes hydrogen sulphide and other sulfur compounds

- Over 70% of the natural gas is formed by methane.

-It is Colorless, odorless and mostly constitutes methane which is a relatively unreactive hydrocarbon.

Utilization:

-Natural gas is widely used for different purposes such as space heating, electricity generation, industrial processes, agricultural, raw material for petrochemical industry, residential, commercial and utility markets

-On a gallon equivalent basis, natural gas costs less than gasoline, diesel fuel or any other alternative fuel. Natural gas currently supplies over 25% of the energy demand because of its quality.

-can either be stored on board a vehicle in tanks as compressed natural gas (CNG) at pressure of 16 to 25 bar or cryogenically cooled to a liquid state (-127 °C) as liquefied natural gas (LNG) at pressure of 70 to 120 bar. As a fuel and with a single throttle body injector it works best in an engine system. LNG is used in heavy duty vehicles where use of CNG would still entail space and load carrying capacity penalties. The fuel storage system of natural gas as LNG instead of CNG is less than half the weight and volume of CNG system. So, it can be easily transportable than CNG.

(i) CNG (Compressed Natural Gas)

-Natural gas consists of elements of compressor, some sort of compressed gas storage and dispensing unit of CNG into vehicles

-Two types of CNG refueling system- slow fill and fast fill. In slow fill system, several vehicles are connected to the output of the compressor at one time. These vehicles are then refilled over several hours of compressor operation. In fast fill systems, enough CNG is stored so that several vehicles can be refueled one after the other, just like refueling from a single gasoline dispenser

-The storage system of CNG is arranged as several tanks in cascade form. The CNG pressure in cascade is higher than the maximum storage pressure of the cylinder on the vehicle. The cascade attempts to deliver as much of its CNG to vehicles as possible before the pressure difference decreases to where the flow rate slows dramatically. A dryer should include in most CNG refueling systems to remove water vapor, impurities and hydrogen sulphide from natural gas before it is compressed. If water vapor is present then it can condense in the vehicle fuel system, causing corrosion especially if hydrogen sulphide is present. CNG driven vehicles with catalytic converter have less CO and HC emission but NO_x emission is high

(ii) LPG (Liquefied Petroleum Gas)

-LPG is available in the market in two forms- one is propane and the other is butane. Propane is popular alternative fuel because of its infrastructure of pipe lines, processing facilities and storage for its efficient distribution and also it produces fewer emissions. Propane is produced as a byproduct of natural gas processing and crude oil refining

-Natural gas contains LPG, water vapor and other impurities and about 55% of the LPG is compressed from natural gas purification. LPG is a simple mixture of hydrocarbon mainly propane/propylene (C₃S) and butane/ butylenes (C₄S)

-Propane is an odorless, nonpoisonous gas which has lowest flammability range.

Utilization of LPG

LPG is used as a fuel in heating appliances and vehicles. It is increasingly used as an aerosol propellant and a refrigerant, replacing chlorofluorocarbons in an effort to reduce damage to the ozone layer

-In Europe, LPG is used as an alternative to electricity and heating oil (kerosene).It can also be used as power source for combined heat and power technologies (CHP). CHP is the process of generating both electrical power and useful heat from a single fuel source. This technology has allowed LPG to be used not just as fuel for heating and cooking, but also for de-centralized generation of electricity

-LPG has higher potential as an alternate fuel for IC engine.

Advantages of LPG

-Emission is much reduced by the use of LPG.

-LPG mixes with air at all temperatures.

-Uniform mixture can be supplied to all cylinders of multi-cylinder engine.

-Engine with high compression ratio (10:1) can use propane.

-There is cost saving of about 50% and longer life with LPG running engine.

Disadvantages of LPG

(i) A good cooling system is necessary because LPG vaporizer uses engine coolant to provide the heat to convert the liquid LPG to gas [2].

(ii) The weight of vehicle is increased due to the use of heavy pressure cylinder for storing LPG.

(iii) A special fuel feed system is required for LPG.

(iv) Requirement of safety device to prevent accident due to explosion of gas cylinders or leakage in the gas pipes.

(f) Producer Gas:

-Producer gas is a product of oxidation-reduction reactions of air with biomass. Biomass is chemically composed of elements C, H, O and some N and hence the oxidation results in products of combustion like CO₂ and H₂O. The molecules of O₂ in the air oxidises C and H to produce these products. The gases which are at high temperature due to partial oxidation pass through a bed of charcoal (which is produced because of oxidation reaction itself) and the reduction reaction of these gases with carbon leads to carbon monoxide and hydrogen

-Volumetric composition of producer gas is CO (16-20%), H₂ (16-18%), CO₂ (8-10%) and some traces of higher hydrocarbons. Producer gas has a high percentage of N₂, since air is used. So it has a low heat value. Density of producer gas is 0.9 to 1.2 kg/m³

-Producer gas is used in reciprocating engines and furnace. It needs little air to burn stoichiometrically and raise the temperature to a value of 1500 K at normal temperature and pressure. It is also used to power gas turbines (which are well-suited to fuels of low calorific value), spark ignited engines (where 100% petrol fuel replacement is possible) or diesel internal combustion engines (where 40% - 15% of the original diesel fuel) is still used to ignite the gas.

(g) Blast Furnace Gas:

It is a byproduct of melting iron ore in steel plants. It principally consists of CO and contains low heat value similar to producer gas. It consists of about 60% nitrogen, 18-20% CO₂ and some amount of oxygen which are not flammable. It may be combined with natural gas or coke oven gas before combustion or a flame support with richer gas or oil is provided to sustain combustion. The auto ignition temperature of blast furnace gas is approximate 630 °C and it has Lower Explosive Limit (LEL) of 27% &Upper Explosive Limit (UEL) of 75% in an air-gas mixture at normal temperature and pressure. The gas is hazardous due to higher concentration of carbon monoxide [50].It should be cleaned properly because it contains lot of dust particles. Blast furnace gas depends upon types of fuel used and method of operating the blast furnace.

(h) Coke Oven Gas:

It is produced during the making of coke. It is also resulting from oxidation-reduction reactions of coal or coke with air and sometimes steams. It depends upon the type of coal used and operation method of oven. The composition of coke oven gas is H₂ (54% vol), CH₄ (24%), CO (8%), CO₂ (6%) and some traces of higher hydrocarbon and nitrogen. With the application of heat the heavier hydrocarbons are cracked and volatile portion of coal is driven off and results in high composition of H₂and CH₄. Its heat value per cubic meter is only about one half that of natural gas and density is 0.40 kg/m³.

***General Fuel Specifications:**

Different properties of fuels have,

Relative density (specific gravity)

Fuel composition

Specific heating value

Flash point

Viscosity

Surface tension

Freezing point

(a) Relative density (specific gravity):

It is related to the measurement of the ratio of the weight of a given volume of fuel to the weight of the same volume of water, both at 20 °C and 101.325 kPa

For gasoline, the relative density is around 0.72 to 0.78 - which is equivalent to an API (American petroleum institute) range of 65 to 50,

$\rho = 700 - 800 \text{ [kg/m}^3\text{]}$, for unleaded gasoline this value is higher due to the aromatics

For diesel fuel, $\rho = 830 - 950 \text{ [kg/m}^3\text{]}$

(b) Fuel composition:

C and H: carbon content of aromatics is around 89 %, and of paraffins and naphthenes is around 86 %

Benzene: max allowable concentration is specified because it is highly toxic material, the level is 5 %

Sulphur content: HC fuels contain free sulphur, hydrogen sulphide and other sulphur compounds which are objectionable it is a corrosive element that can corrode fuel lines, carburettor and injection pump. It will unite with oxygen to form sulphur dioxide, which in presence of water at low T, forms sulphurous acid.

-It has low ignition T, promote knock in SI engines. limited to approx 250 ppm (50 ppm is aimed for low pollutant emitting vehicles)

Gum deposits: gasoline with unsaturated HCs forms gum in the engine, paraffin, naphthene and aromatic HCs also form some gum – it causes operating difficulties, sticking valves and piston rings, deposits in the manifold etc.

Water: both dissolved and free water can be present in gasoline, free water is undesirable because it can freeze and cause problems. Dissolved water is usually unavoidable during manufacture.

Lead: for leaded and unleaded gasoline max lead content is specified, lead causes pollution and destroys catalytic converters in the exhaust system.

Manganese: used for antiknock in gasoline (MMT), max amount is specified, 0.00025 to 0.03 gMn/L

Oxygenates: oxygenated compounds such as alcohols are used in gasoline to improve octane rating.

In USA gasohol (10% ethanol contains 3.5% oxygen), TBA and methanol up to 3.5% oxygen methanol up to 5% volume, MTBE up to 15% are used. In EC monoalcohols and ethers with atm boiling points lower than the final atm boiling point of gasoline in the standards can be used. Higher concentrations require modifications on the vehicles - carburetor or fuel injection system must be modified to compensate for the oxygen content of the fuel. Blends with 15% methanol can be used.

(C) Specific heating value:

-Specific heating value, H_u is a measure of the energy content of the fuel per unit mass (kJ/kg or kcal/kg)

-Gaseous fuels sp heating value is given in terms of energy content per unit volume (kJ/liter or kJ/m^3 , kcal/m^3)

-In IC engines lower heating value is given as the combustion products contain water in vapour form.

For gasoline and diesel fuel

$H_u=42000-44000$ kJ/kg or $H_u=10200-10500$ kcal/kg

-Heating value of the combustible air-fuel mixture is a decisive factor for engine performance.

(d) Flash point:

-Flash point is the lowest temperature of a sample at which the fuel vapour starts to ignite when in contact with a flame (ignition source).

-Marcusson method – fuel container is slowly heated, while the fuel vapour is in contact with an open flame – T is measured

-For gasoline it is 25 °C, diesel fuel 35 °C and heavy diesel 65 °C

(e) Viscosity:

-Viscosity is an important parameter for CI engines, also influences fuel metering orifices since Re is an inverse function of fuel viscosity lower the viscosity, smaller the diameter of the droplets in the spray.

-Below certain limits, low viscosity increases the leaks in the fuel system. It is a strong function of T – must be given at certain T values

at 50 °C, 1.5 – 5.0 Engler or 0.5 to 0.6 centistokes

(f) Surface tension:

-Surface tension is a parameter which effects the formation of fuel droplets in sprays

-increasing the surface tension will reduce mass flow and air-fuel ratio in gasoline engines

-lower the value, smaller the droplet diameter

diesel fuel value is in the range of 0.023 – 0.032 N/m

and for gasoline it is 0.019 – 0.023 N/m

(g) Freezing point:

-the precipitation of paraffin crystals in winter can lead to clogged filters. It can be prevented by either removing paraffins from the fuel or adding flow improvers (additives).

-Antifreezing properties are determined by its filterability.

-For gasoline freezing point is –65 °C and for diesel fuel –10 °C

***Important fuel specifications for gasoline**

(a) Gasoline volatility:

Benzene for example has vapor pressure of 0.022 MPa at 38 OC in a closed container of 38 OC, benzene evaporates until the partial p

has a value of 0.022 MPa, If T is raised to 80.5 OC, then saturation p will be 0.1 MPa and will be constant during the boiling

For gasoline it is not possible to indicate a single value of evaporation T or vapor pressure.

Gasoline contains large number of compounds - up to about 400

It has a smooth distillation curve - with good fractionation efficiency

Low fractionation efficiency effects engine performance at different operating conditions:
If distillation curve is displaced downward, gasoline becomes more volatile - poor hot start, vapor lock, high evaporative losses

Gasoline distillation curve:

Gasoline having boiling point up to 70 OC controls ease of starting and hot weather problems such as vapor lock

Mid-range controls the driving in cold weathers, particularly at warm up period of engine. It also influences the ice forming in carburetor.

Back end of the curve contains all the heavier, high boiling point compounds and these have high heat content - they are important in improving fuel economy for fully warmed up engine.

Some of the heavier compounds may pass into the crankcase and dilute the crankcase oil. They are not readily combusted as the lighter compounds - cause combustion chamber deposits.

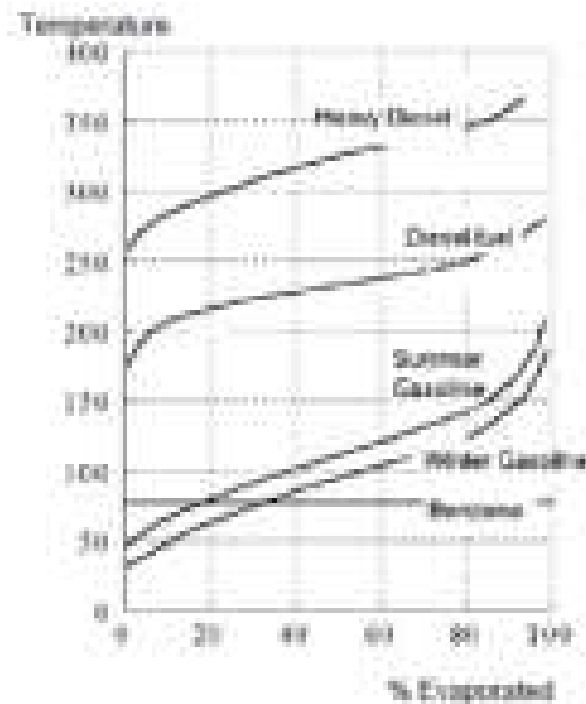

Fig. 12. Distillation curve

%10 evaporation point should be at low T for start up at cold temperatures - at hot weathers this may cause problems - vapor lock.

50% evaporation should be slightly above 100 OC at summer and slightly below 100 OC at winter. For warmed up engine conditions this point is not important.

90% evaporation must not be high - produces fuel film on intake manifold walls and dilutes lubricating oil. Back end of the curve must not exceed 215 OC.

Gasoline volatility should be arranged according to weather conditions -particularly ambient T. Altitude has some minor effect due to pressure changes.

It is also effected by the characteristics of the vehicle itself (drivability, fuel system design etc).

Cold starting:

For SI engines to start, A/F ratio must be within the ignitable range, ie in general must be between 7:1 to 20:1 by weight.

When the engine is cold, it is difficult to ignite lean mixtures, because fuel may not vaporize sufficiently - under these conditions the mixture is rich to bring it to ignitable range. This is done by the injection time or by the use of a choke with carburetted engines.

Measurement of gasoline volatility:

Tests usually define Reid Vapour Pressure - ASTM Distillation test and Vapour/Liquid ratio.

Reid vapour pressure - obtained at air-to-liquid ratio of 4:1 and temperature 37.8 °C.

Fuel is filled into a metal chamber which is connected to an air chamber and that is connected to a pressure gauge. The apparatus is immersed in water bath at 37.8 °C and is shaken until constant p is obtained - Reid VP

For gasoline allowable RVP is 0.7 bar in summer and 0.9 bar in winter (at 37.8 °C)

ASTM Distillation procedure - distillation rate is controlled by the heat input - distillation curve is plotted (temperature vs % evaporated).

(b)Antiknock quality of gasoline:

-Knock occurs when the unburnt gases ahead of flame front (the end gases) spontaneously ignite causing a sudden rise in pressure accompanied by a characteristic pinging sound – this result in a loss of power and can lead to damage the engine.

-Combustion chamber shape, spark plug location, ignition timing, end gas temperatures, in cylinder gas motion, air-fuel ratio of the mixture, fuel specifications etc. effects the occurrence of knock.

-Compression ratio of the engine also strongly effects knock. The higher the CR, the better the thermal efficiency - but the greater the tendency for knock to occur.

-Critical compression ratio - when knock starts. So higher fuel octane quality is required.

-Autoignition of the end gases causes a rapid increase of p, producing p waves which resonate in the combustion chamber at a frequency of between 5000 - 8000 Hz, depending on the geometry of the chamber

Knock results in an increase of T in the cylinder and causes a severe damage to engine components like cylinder head gasket, piston, spark plugs etc.

Octane number:

-In 1929 Octane scale was proposed by Graham Edgar. In this scale two paraffinic HCs have been selected as standards (PRF, primary reference fuels)- iso-octane (2-2-4 trimethyl pentane) with very high resistance to knock (arbitrarily assigned a value of 100) and n-heptane with extremely low knock resistance (assigned a value of 0).

-Octane number of the fuel is the volume percentage of iso-octane in a blend with n-heptane (PRF), that shows the same antiknock performance as test fuel tested in standard engine and standard conditions.

-Test engine for determining Octane values, was developed by Cooperative Fuel Research Committee (CFR). It is a single cylinder, variable CR engine.

-Two different test conditions specifies the Research Octane Number (RON) and the Motor Octane Number (MON)

-Antiknock Index = $(RON + MON) / 2$

-TEL is added to the PRF to increase the ON above 100 or n-heptane is added to the sample to reduce ON below 100, then nonlinear extrapolation is applied

ON can be increased by antiknock agents - at less expense than modifying HC composition by refinery process.

Most effective agents are lead alkyls -

TEL - tetraethyl lead, $(C_2H_5)_4 Pb$

TML - tetramethyl lead,

MMT

addition of about 0.8 g lead per litre, provides a gain of about 10 ON in gasoline

***Important fuel specifications for diesel**

(a) Viscosity:

-Viscosity of a fluid indicates its resistance to flow - higher the viscosity, the greater the resistance to flow.

-It may be expressed as absolute viscosity (Poise, P) or kinematic viscosity (stoke, St).

-It varies inversely with temperature, usually given at 20 - 40 °C

-Fuel atomization depends on viscosity

2 - 8 mm²/s (cSt) at 20 °C

-Lower the viscosity, smaller the diameter of the droplets in the spray

(b) Surface tension:

-Surface tension is a parameter which effects the formation of fuel droplets in sprays

-Lower the value, smaller the droplet diameter

-Diesel fuel 0.023 – 0.032 N/m

(c) Cetane number:

-Cetane number is used to specify the ignition quality of diesel fuel.

-Running on low Cetane number will produce cold start problems. Peak cylinder pressure, combustion noise and HC emissions will increase -more fuel will be injected before ignition, less time for combustion.

-Higher CN results in a sooner ignition - extremely high CN may ignite before adequate Fuel-Air mixing can take place - higher emissions. Power output can be reduced if burning starts too early.

Measurement of cetane number:

-Cetane number is measured by comparing the “ignition delay time” of the sample fuel with a mixture of cetane (C₁₆H₃₄) and alphas-methyl naphthalene (C₁₀H₇CH₃). The Cetane percentage in the mixture gives the CN of the sample fuel.

-CN of the reference fuel cetane is arbitrarily set at 100, and of alphas-methyl naphthalene at 0.

-CFR engine is used to measure the compression ratio at which ignition starts. CR is gradually increased while the engine is driven by an electric motor - a curve of CN vs critical CR is obtained.

-Inlet air temp is 30 °C and cooling water temp is at 100 °C

An easier and practical method to obtain Cetane Number is by calculating the Diesel Index.

Increasing the DI, increases the tendency to ignite.

$$DI = \frac{\text{Annilin point } [^{\circ}\text{F}] \times \text{API}[at 60 ^{\circ}\text{F}]}{100}$$

-AP is obtained by heating equal amounts of annilin and diesel fuel. While cooling down, the temp at which the annilin separates from the mixture is the AP

-Cetane number is in the range of,

50 - 60 for high speed Diesel engines

25 - 45 for low speed Diesel engines

Normal Diesel fuel CN is 40 - 55

DI of 50 gives a CN of around 50

***Carburetion:**

The process of preparing a combustible fuel-air mixture outside engine cylinder in SI engine is known as carburetion.

Important factors which affect the process of carburetion are given below;

- time available for the mixture preparation i.e. atomisation, mixing and the vaporisation
- Temperature of the incoming air
- quality of the fuel supply
- design of combustion chamber and induction system

***Mixture requirements for steady state operation:**

Three main areas of steady state operation of automotive engine which require different air fuel ratio are discussed below,

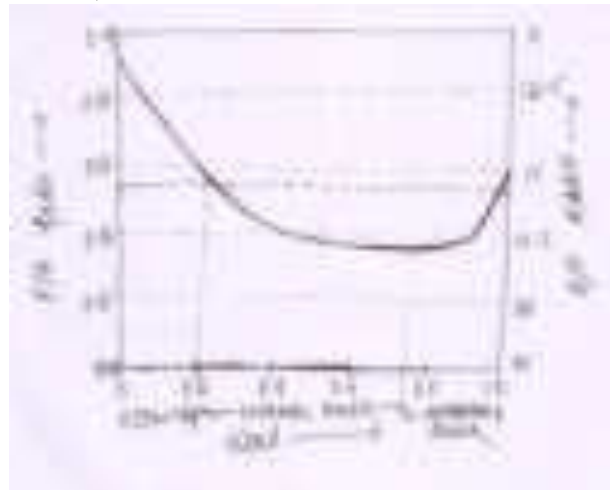

Fig. 13. Main areas of automotive engine operation

(a) Idling and low load:

- from no load to about 20% of rated power
- No load running mode is called idling condition
- very low suction pressure give rise to back flow of exhaust gases and air leakage
- increases the amount of residual gases and hence increase the dilution effects
- Rich mixture i.e. F/A ratio 0.08 or A/F ratio 12.5:1 provide smooth operation of the engine

(b) Normal power range or cruising range:

- from about 20% to 75% of rated power
- dilution by residual gases as well as leakage decreases, hence fuel economy is important consideration in this case
- maximum fuel economy occurs at A/F ratio of 17:1 to 16.7:1
- mixture ratios for best economy are very near to the mixture ratios for minimum emissions

(c) Maximum power range:

- from about 75% to 100% of rated power
- mixture requirements for the maximum power is a rich mixture, of A/F about 14:1 or F/A 0.07

- Rich mixture also prevents the overheating of exhaust valve at high load and inhibits detonation
- in multi-cylinder engine the A/F ratio are slightly lower

***Mixture requirements for transient operation:**

- Carburettor has to provide mixture for transient conditions under which speed, load, temperature, or pressure change rapidly
- evaporation of fuel may be incomplete in the transient condition, quantity of fuel may be increasing and decreasing

(a) Starting and warm up requirements:

- engine speed and temperature are low during the starting of the engine from cold
- during starting very rich mixture about 5 to 10 times the normal amount of petrol is supplied i.e. F/A ratio 0.3 to 0.7 or A/F ratio 3:1 to 1.5:1
- mixture ratio is progressively made leaner to avoid too rich evaporated fuel-air ratio during warm up condition
- too high volatility may form vapour bubbles in the carburettor and fuel lines particularly when engine temperatures are high
- too low volatility may cause the petrol to condense on the cylinder walls, diluting and removing the lubricating oil film

(b) Acceleration requirements:

- Acceleration refer to an increase in engine speed resulting from the opening of the throttle
- acceleration pump is used to provide additional fuel

***Simple Carburettor:**

- provide air-fuel mixture for all operating conditions
- Carburettor depression is pressure differential in the float chamber and venture throat which causes discharge of fuel into the air stream
- flow is controlled by small hole of fuel passage
- pressure at the throat at the fully open throttle condition lies between 4 and 5 cm of Hg and seldom exceeds 8 cm Hg
- petrol engine is quantity governed
- Drawback of simple carburettor is that it provides too rich and too lean mixture due to vacuum created at the throat is too high and too small which is undesirable

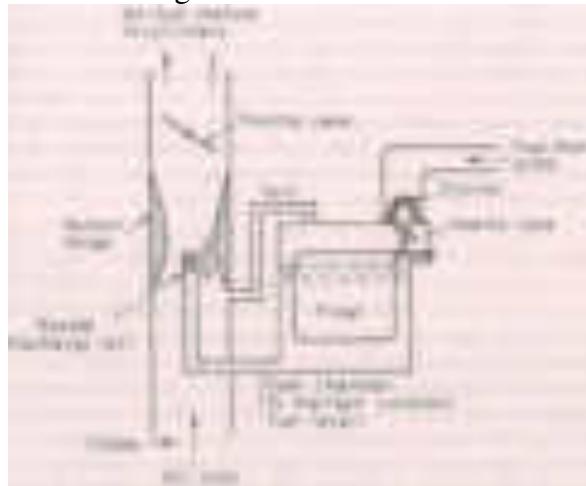

Fig. 14. A simple carburettor

***Complete Carburettor:**

Additional systems used with simple carburettor can help the engine to operate at all conditions, which are given below,

(i) Main metering system:

- provide constant fuel-air ratio at wide range of speeds and loads.
 - mainly based upon the best economy at full throttle (A/F ratio about 15.6:1)
- The different metering systems are,

Compensating jet device:-Addition to the main jet, a compensating jet is provided to provide the leanness effect

Emulsion tube or air bleeding device:

- mixture correction is done by air bleeding alone
- in this arrangement main metering jet is fitted about 25 mm below the petrol level which is called as submerged jet

Back suction control or pressure reduction method:

- in this arrangement large vent line connects the carburettor entrance with the top of the float chamber and another small orifice line is connected with the top of the float chambers with venturi throat
- it creates pressure differences according to engine operating conditions

Auxiliary valve carburettor:

- Valve spring of auxiliary valve lift the valve during increase of engine load which increases the vacuum at venturi
- Allows more admittance more additional air and the mixture is not over rich

Auxiliary port carburettor:

- opening of butterfly allows more air inductance which decreases quantity of fuel drawn
- used in aircraft carburettors

(ii) Idling system:

- Idling jet is added for the idling and low load operation which requires rich mixture so about A/F ratio 12:1
- consists of small fuel line from the float chamber to a point of throttle side
- gradual opening of throttle may stop the idling jet

(iii) Power enrichment or economiser system:

- this system provides the richer mixture for maximum power range of operation
- It has meter rod economiser of large orifice opening to the main jet as the throttle is opened beyond a certain point
- rod is tapered or stepped

(iv) Acceleration pump system:

- Engine acceleration condition or rapid increase in engine speed may open the throttle rapidly which will not be able to provide rich mixture
- acceleration pump of spring loaded plunger is used for fuel supply

(v) Choke:

- Rich mixture is required during cold starting period, at low cranking speed and before the engine warmed up condition
- butterfly type valve or choke is used between the entrance to the carburettor and venturi throat to meet the requirement
- spring loaded by-pass choke is used in higher speeds

***Carburettor types:**

(i) Open choke: Zenith, Solex and Carter
Constant vacuum type: S.U. carburettor

(ii) Updraft type

Horizontal or downdraft: mixture is assisted by gravity in its passage to the engine induction

(a) Solex carburettor:

- provide ease of starting, good performance, and reliability
- used in Fiat and standard cars and Willy Jeep
- Bi-starter is used for cold starting
- well of emulsion system is used for idling and slow running condition
- diaphragm type acceleration pump is used for increasing speed case

(b) Carter carburettor:

- downdraft type carburettor used in Jeep
- has triple venturi diffusing type choke in which smallest lies above the level float chamber, other two below the petrol level, one below other
- multiple venturies result in better formation of the mixture at very low speeds causing steady and smooth operation at very low and high engine speed
- mechanical metering method is used
- choke valve is provided in the air circuit for cold starting
- plunger type acceleration pump is used

(c) S.U. carburettor:

- constant air-fuel ratio is maintained due to vacuum depression
- has only one jet
- no separate idling jet or acceleration pump
- constant high velocity air across the jet may avoid the use of idling jet
- jet lever arrangement provides the rich mixture in cold starting
- used in many British cars and Hindustan Ambassador car

Drawbacks of modern carburettor:

- improper mixture proportion in multi-cylinder engine
- loss of volumetric efficiency due to obstruction of flow of mixture from choke tubes, jets, throttle valve etc.
- wear of carburettor parts
- Freezing at low temperature
- surging when carburettor is tilted or during acrobatics in aircraft
- backfiring in fuel pipe line

Petrol injection:

- to avoid above problem of modern carburettor, petrol injection is used like in diesel engine
- petrol injected during the suction stroke in the intake manifold at low pressure
- injection timing is not much critical as like in diesel engine
- continuous injection and timed injection methods are used

Continuous injection:

- fuel is sprayed at low pressure continuously into the air supply
- amount of fuel is governed by air throttle opening
- in supercharged engine, fuel injected in the form of multiple spray into the suction side of the centrifugal compressor
- provide efficient atomisation of fuel and uniform mixture strength to all cylinder
- higher volumetric efficiency
- one fuel injection pump and one injector

Timed injection system:

- similar to high speed diesel engine
- components are fuel feed or lift pump, fuel pump and distributor unit, fuel injection nozzles and mixture controls
- mixture controls are automatic for all engine operating conditions

(i) Multiple plunger jerk pump system:

- pump with separate plunger and high injection nozzle pressure for each cylinder
- 100 to 300 bar pressure
- measured quantity of fuel for definite time and over definite period is delivered

(ii) Low pressure single pump and distributor system:

- single plunger or gear pump supply fuel at low pressure to a rotating distributor
- pressure about 3.5 to 7 bar

(a) Lucas petrol injection system:

- firstly used in racing car
- single distributor system with novel metering device
- line pressure is maintained at 7 bar
- metering distributor and control unit distributes the required amount of fuel at correct time and interval
- has shuttle arrangements for metering unit
- in aircraft engine two injectors and spark plug provided for direct injection of fuel in combustion chamber

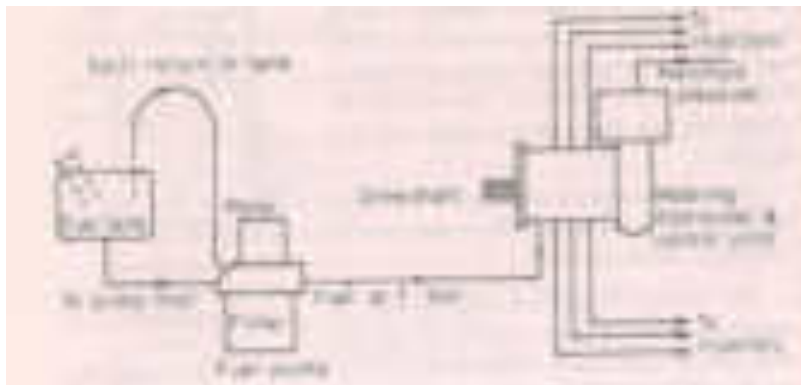

Fig. 15. Lucas petrol injection system for 6-cylinder petrol engine

(b) Electronic fuel injection

Fuel delivery system:

- electrically driven fuel pump draws fuel from tanks to distribute
- fuel and manifold pressure kept constant by pressure regulator

Air induction system:

- air flow meter generate voltage signal according to air flow
- cold start magnetic injection valve give good fuel atomisation and also provide extra fuel during warm up condition

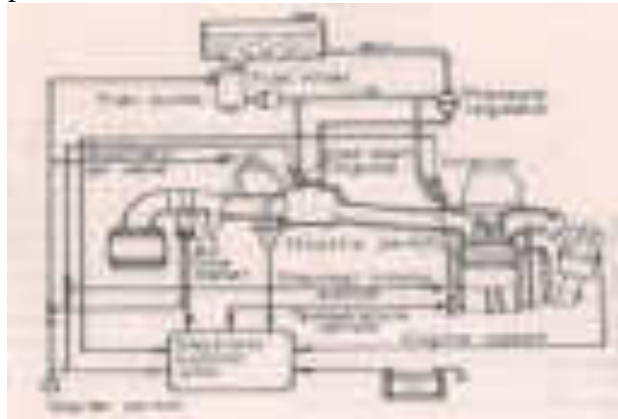

Fig. 16. Electronic fuel injection system- L-Jetronic with air flow meter

Electronic control unit (ECU):

- sensors for manifold pressure, engine speed and temperature at intake manifold
- sensor measures operating data from locations and transmitted electrically to ECU

Injection timing:

- injected twice for every revolution of crank shaft
- triggering of injectors

***Diesel injection system:**

Requirements of diesel injection system:

- fuel must introduce precisely defined period of cycle
- amounts metered very accurately
- rate of injection meet desired heat release pattern
- quantities of fuel meet changing speed and load condition
- good atomisation of fuel
- good spray pattern for rapid mixing of fuel and air
- no dribbling and after injection of fuel i.e. sharp injection
- injection timing suits the speed and load requirements
- distribution of fuel in multi-cylinder should uniform
- weight, size and cost of fuel injection system should be less

Types of diesel injection system:

(a) Air injection system:

- fuel supplied through camshaft driven fuel pump
- fuel valve is also connected with high pressure airline to inject into cylinder
- multi-stage compressor which supply air at a pressure of about 60 to 70 bar

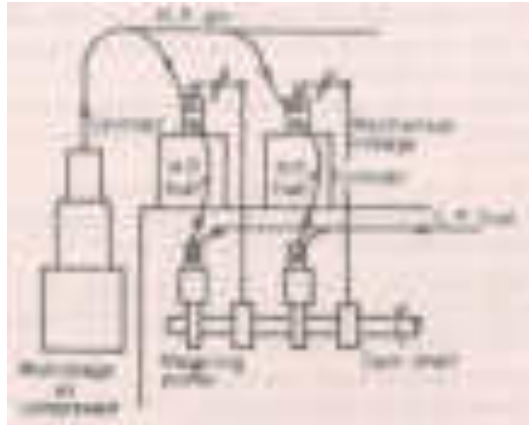

Fig. 17. Air injection system

- blast air sweeps the fuel along with it
- good atomisation results in good mixture formation and hence high mean effective pressure
- heavy and viscous fuels are used
- fuel pump require small pressure
- but it is complicated due to compressor arrangement and expensive
- bulky engine and low bhp
- overheating and burning of valve seat

(b) Solid injection system:

-Fuel directly injected to combustion chamber without primary atomisation termed as solid injection.

-Also known as airless mechanical injection

-2 units-pressurise and atomising unit

3 different types which are described below,

(i) Individual pump and injector or jerk pump system:

-separate metering and compression pump is used for each cylinder

-reciprocating fuel pump is used to meter and set the injection pressure of the fuel

-heavy gear arrangements which gives jerking noise, hence name is given is jerk pump

-jerk pump is used for medium and high speed diesel engines

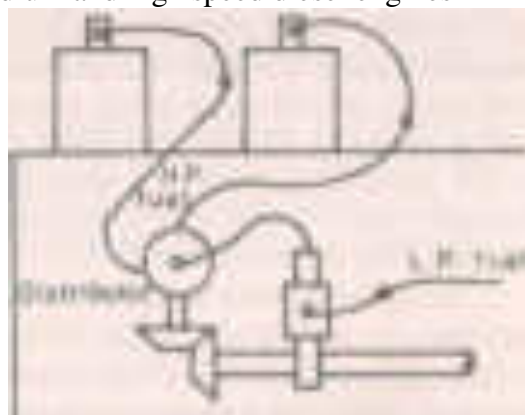

Fig. 18. Individual pump and injector or jerk pump system

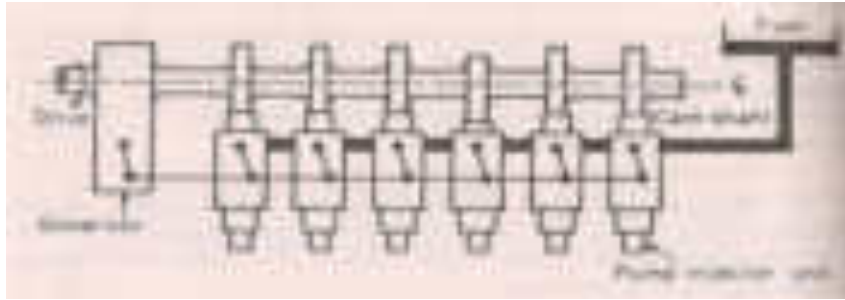

Fig. 19. Unit injector

(ii) *Common rail system:*

- high pressure fuel pump delivers fuel to an accumulator whose pressure is constant
- plunger type of pump is used
- driving mechanism is not stressed with high pressure hence noise is reduced
- common rail or pipe is connected in between accumulator and distributing elements
- separate metering and timing elements connected to automatic injector
- self-governing type

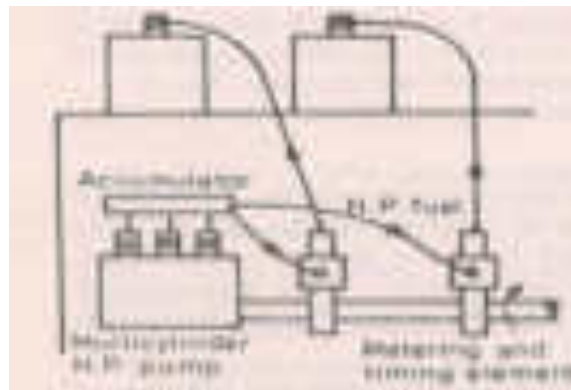

Fig. 20. Common rail system

(iii) *Distributor system:*

- fuel pump pressurises, meters and times the fuel supply to rotating distributor
- number of injection strokes per cycle for the pump equals to the number of cylinder
- One metering element which ensure uniform distribution

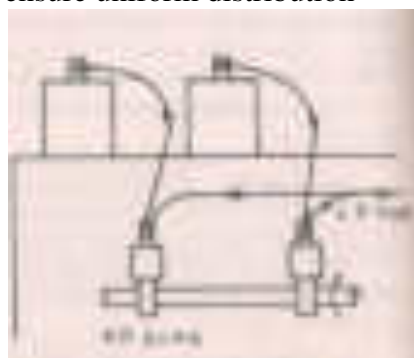

Fig. 21. Distributor system

*** Fuel Injectors**

3 main types of fuel injectors,

Blast injector:

- these are superseded by mechanically operated injectors used in air injection system

Mechanically operated injector:

-consist of a set of camshaft, cams and rocker gear and other cams for controlling the timing of the fuel injection

Automatic injector:

-consists of spring loaded needle valve and operated hydraulically by the pressure of fuel
-quantity of fuel is metered by the fuel pump

Types of nozzles:

(a) Depends on the type of combustion chamber,

Open combustion chamber:

-fuel seeks air
-air swirl is created due to inclined induction port
-multi-hole nozzle injects fuel at a pressure of about 200 to 300 bar to slow moving air
-provide good cold starting performance and improved thermal efficiency

Pre-combustion chamber:

-air velocity is very much high
-single hole nozzle with 65 to 100 bar injection pressure is used
-used in high speed engine due to rapid combustion
-external heating device for easy starting of the engine

(b) Open and closed type of nozzle,

Open type:

-consists of fuel orifices and open to burner
-cheap and less efficient
ex- opposed piston two-stroke Junkers diesel engine

Closed type: pressure drop is minimised compared to open type

(c) Different types of nozzle for different combustion chamber

(i) Single hole nozzle:

-used in open combustion chamber
-size of hole larger than 0.2 mm
-very high injection pressure required

(ii) Multi-hole nozzle:

-no. of hole varies from 4 to 18 and the size from 1.5 to 0.35 mm
-injection rate is not uniform

(iii) Pintle nozzle:

-a projection or pintle is provided in the nozzle to avoid weak injection and dribbling
-pintle may be cylindrical or conical shape
-cone angle varied from 0 to 60°
-provide good atomisation and reduced penetration
-fuel pressures are lower than single and multi-hole nozzle

(iv) Pintaux nozzle:

-injected fuel in upstream of air
-development of pintle nozzle with auxiliary hole drilled in the nozzle body
-reduced delay period and increased thermal efficiency

Module-II

IGNITION SYSTEM

Basically Convectional Ignition systems are of 2 types:

- (a) Battery or Coil Ignition System, and
- (b) Magneto Ignition System

Both these conventional, ignition systems work on mutual electromagnetic induction principle.

Battery or Coil Ignition System:

-used in 4-wheelers, but now-a-days it is more commonly used in 2-wheelers also (i.e. Button start, 2-wheelers like Pulsar, Kinetic Honda; Honda-Activa, Scooty, Fiero, etc.)

- The ignition system is divided into 2-circuits:

(i) Primary Circuit:

-consists of 6 or 12 V battery, ammeter, ignition switch, primary winding

-it has 200-300 turns of 20 SWG (Sharps Wire Gauge) gauge wire, contact breaker, capacitor.

(ii) Secondary Circuit:

-consists of secondary winding or coil which have 21000 turns of 40 (S WG) gauge wire.

-bottom end of which is connected to bottom end of primary and top end of secondary winding or coil is connected to centre of distributor rotor.

-distributor rotors rotate and make contacts with contact points and are connected to spark plugs which are fitted in cylinder heads.

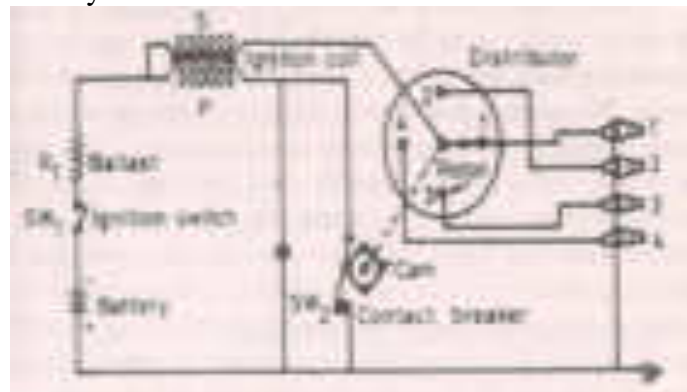

C=condenser, P=primary coil, S=secondary coil, R1=ballast resistance, SW1=ignition switch, SW2=contact breaker

Fig. 22. Circuit diagram for a conventional spark ignition system

Working:

-When the ignition switch is closed and engine is cranked, as soon as the contact breaker closes, a low voltage current will flow through the primary winding. It is also to be noted that the contact breaker cam opens and closes the circuit 4-times (for 4 cylinders) in one

revolution. When the contact breaker opens the contact, the magnetic field begins to collapse. Because of this collapsing magnetic field, current will be induced in the secondary winding. And because of more turns (@ 21000 turns of secondary, voltage goes unto 28000-30000 volts. This high voltage current is brought to centre of the distributor rotor. Distributor rotor rotates and supplies this high voltage current to proper stark plug depending upon the engine firing order. When the high voltage current jumps the spark plug gap, it produces the spark and the charge is ignited-combustion starts-products of combustion expand and produce power.

- The Function of the capacitor is to reduce arcing at the contact breaker (CB) points. Also when the CB opens the magnetic field in the primary winding begins to collapse. When the magnetic field is collapsing capacitor gets fully charged and then its tarts discharging and helps in building up of voltage in secondary winding.
- Contact breaker cam and distributor rotor are mounted on the same shaft.
- In 2-stroke cycle engines these are motored at the same engine speed. And in 4-stroke cycle engines they are motored at half the engine speed.
- A good spark is available at low speed also.
- Occupies more space.
- Recharging is a must in case battery gets discharged.

Magneto Ignition System:

- magneto will produce and supply the required current to the primary winding or coil
- rotating magneto with fixed coil or rotating coil with fixed magneto for producing and supplying current to primary, remaining arrangement is same as that of a battery ignition system
- no battery required
- during starting the quality of spark is poor due to slow speed
- very much compact

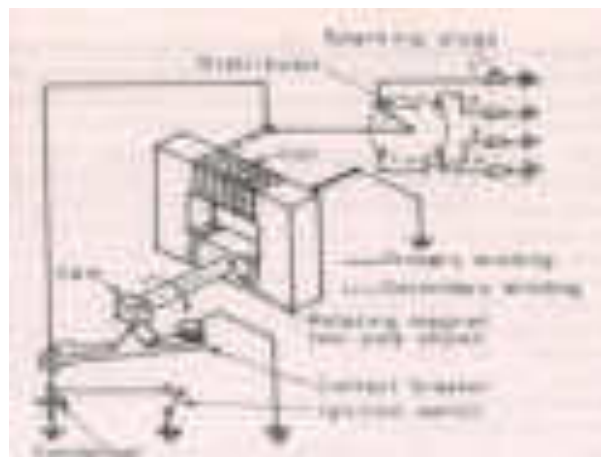

Fig. 23. High tension magneto ignition system

Disadvantage of conventional ignition systems

Following are the drawbacks of conventional ignition systems:

- (a)Because of arcing, pitting of contact breaker point
- (b)Poor starting: After few thousands of kilometres of running, the timing becomes inaccurate, which results into poor starting (Starting trouble).
- (c)At very high engine speed, performance is poor because of inertia effects of the moving parts in the system.

(d) Sometimes it is not possible to produce spark properly in fouled spark plugs.

Due to above problem electronic ignition system is used.

Following are the advantages of electronic ignition system:

- (a) Moving parts are absent-so no maintenance.
- (b) Contact breaker points are absent-so no arcing.
- (c) Spark plug life increases by 50% and they can be used for about 60000 km without any problem.
- (d) Better combustion in combustion chamber, about 90-95% of air fuel mixture is burnt compared with 70-75% with conventional ignition system.
- (e) More power output.
- (f) More fuel efficiency.

Firing order:

The order or sequence in which the firing takes place, in different cylinders of a multi-cylinder engine is called Firing Order.

In case of SI engines the distributor connects the spark plugs of different cylinders according to Engine Firing Order.

Advantages

- (a) A proper firing order reduces engine vibrations
- (b) Maintains engine balancing.
- (c) Secures an even flow of power.
 - Firing order differs from engine-to-engine.
 - Probable firing orders for different engines are :
 - 3 cylinder = 1-3-2
 - 4 cylinder engine (inline) = 1-3-4-2
1-2-4-3
 - 4 cylinder horizontal opposed engine = 1-4-3-2
(Volkswagen engine)
 - 6-cylinder in line engine = 1-5-3-6-2-4
(Crank in 3 pairs) 1-4-2-6-3-5
1-3-2-6-4-5
1-2-4-6-5-3
 - 8 cylinder in line engine 1-6-2-5-8-3-7-4
1-4-7-3-8-5-2-6
 - 8 cylinder V type 1-5-4-8-6-3-7-2
1-5-4-2-6-3-7-8
1-6-2-5-8-3-7-4
1-8-4-3-6-5-7-2

Cylinder 1 is taken from front of inline and front right side in V engines.

Ignition timing:

It is very important, since the charge is to be ignited just before (few degrees before TDC) the end of compression, since when the charge is ignited, it will take some time to come to the required rate of burning.

Ignition Advance:

The purpose of spark advance mechanism is to assure that under every condition of engine operation, ignition takes place at the most favourable instant in time i.e. most favourable from a standpoint of engine power, fuel economy and minimum exhaust dilution. By means of these mechanisms the advance angle is accurately set so that ignition occurs before TDC point of the piston. The engine speed and the engine load are the control quantities required for the automatic adjustment of the ignition timing. Most of the engines are fitted with mechanisms which are integral with the distributor and automatically regulate the optimum spark advance to account for change of speed and load. The two mechanisms used are:

- (a) Centrifugal advance mechanism, and
- (b) Vacuum advance mechanism

Factors affecting energy requirement of ignition system

(a) Effect of series resistance:

- Energy dissipated during discharge and hence circuit energy stored in capacitance is more
- longer discharge time

(b) Effect of electrode material:

- ignition energy for electrode gaps larger than the quenching distance varies with materials for the electrode and increases with any change to material having higher boiling point

(c) Effect of stray inductance:

- presence of small stray inductance cause oscillatory discharge
- larger resistance, minimum inductance longer the discharge time

(d) Effect of electrode configuration:

- reduction in the capacitance reduces the discharge time and increase in the gas resistance which reduces the diameter of the spark channel
- increase the electrode gap means supply of ignition energy over interval of time decreases and spark channel also reduces

*Stages of SI engine combustion

In SI engine homogeneous mixture of vaporised fuel, air and residual gases is ignited by a single intense and high temperature spark between the spark plug electrode (electrodes exceeds 10,000 °C) and generate pre-flame which spreads to envelope of mixture for combustion.

Three stages of combustion in SI engine are,

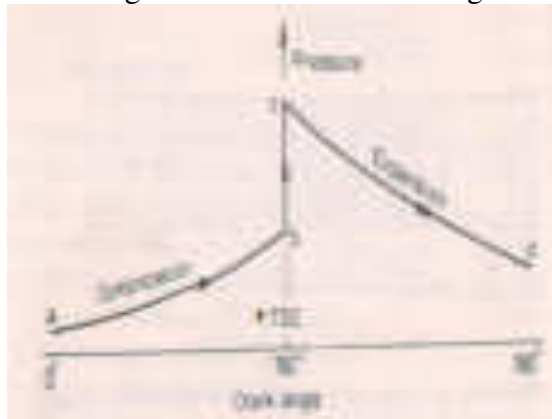

Fig. 24. Theoretical p-θ diagram

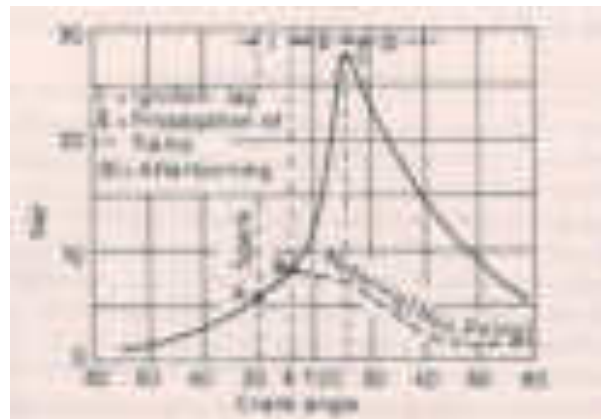

Fig. 25. Stages of combustion in SI engine

I-Ignition lag or preparation phase (AB):

- growth and development of a semi propagating nucleus of flame
- chemical process depending upon the nature of the fuel, upon both temperature and pressure, the proportion of the exhaust gas, and also upon the temperature coefficient of the fuel, that is, the relationship of oxidation or burning
- point A shows the passage of spark and point B is the first rise of pressure
- ignition lag is generally expressed in terms of crank angle
- Ignition lag is very small and lies between 0.00015 to 0.0002 seconds
- ignition lag of 0.002 seconds corresponds to 35 deg crank rotation when the engine is running at 3000 RPM
- Angle of advance increase with the speed

II-propagation of flame (BC):

- Period from the point B where the line of combustion departs from the compression line to point C, the maximum rise of pressure in P- θ diagram
- flame propagates at the constant velocity
- Heat transfer to the cylinder wall is low
- rate of heat release depends upon the turbulence intensity and reaction rate

III-After burning (CD):

- After point C, the heat release is due to the fuel injection in reduced flame front after the starts of expansion stroke
- no pressure rise during this period

***Effect of engine variables on Ignition lag**

Fuel: High self-ignition temperature of fuel longer the ignition lag.

Mixture ratio: mixture richer than the stoichiometric ratio provide shorter ignition lag

Initial temperature and pressure: increasing the intake temperature and pressure, increasing the compression ratio, chemical reaction rate and retarding the spark all reduce the ignition lag

Electrode gap: lower the compression ratio and higher the electrode gap is desirable

-voltage required at the spark plug electrode to produce spark is found to increase with decrease in fuel-air ratio and with increase in compression ratio and engine load

Turbulence: directly proportional to engine speed

-engine speed does not affect much ignition lag measured in milliseconds

-but ignition lag increases linearly with engine speed when measured in degree crank angle

-spark advance is desirable in higher engine speed

***Effect of engine variables on flame propagation**

Rate of flame propagation affects the combustion process in SI engines. Higher combustion efficiency and fuel economy can be achieved by higher flame propagation velocities. Unfortunately flame velocities for most of fuel range between 10 to 30 m/second.

The factors which affect the flame propagations are

1. Air fuel ratio
2. Compression ratio
3. Load on engine
4. Turbulence and engine speed
5. Other factors

1. A:F ratio: The mixture strength influences the rate of combustion and amount of heat generated. The maximum flame speed for all hydrocarbon fuels occurs at nearly 10% rich

mixture. Flame speed is reduced both for lean and as well as for very rich mixture. Lean mixture releases less heat resulting lower flame temperature and lower flame speed. Very rich mixture results incomplete combustion and also results in production of less heat and flame speed remains low.

2. Compression ratio: The higher compression ratio increases the pressure and temperature of the mixture and also decreases the concentration of residual gases. All these factors reduce the ignition lag and help to speed up the second phase of combustion. The maximum pressure of the cycle as well as mean effective pressure of the cycle with increase in compression ratio. Figure above shows the effect of compression ratio on pressure (indirectly on the speed of combustion) with respect to crank angle for same A: F ratio and same angle of advance. Higher compression ratio increases the surface to volume ratio and thereby increases the part of the mixture which after-burns in the third phase.

3. Load on Engine: With increase in load, the cycle pressures increase and the flame speed also increases. In S.I. engine, the power developed by an engine is controlled by throttling. At lower load and higher throttle, the initial and final pressure of the mixture after compression decrease and mixture is also diluted by the more residual gases. This reduces the flame propagation and prolongs the ignition lag. This is the reason, the advance mechanism is also provided with change in load on the engine. This difficulty can be partly overcome by providing rich mixture at part loads but this definitely increases the chances of afterburning. The after burning is prolonged with richer mixture. In fact, poor combustion at part loads and necessity of providing richer mixture are the main disadvantages of SI engines which causes wastage of fuel and discharge of large amount of CO with exhaust gases.

4. Turbulence: Turbulence plays very important role in combustion of fuel as the flame speed is directly proportional to the turbulence of the mixture. This is because, the turbulence increases the mixing and heat transfer coefficient or heat transfer rate between the burned and unburned mixture. The turbulence of the mixture can be increased at the end of compression by suitable design of the combustion chamber (geometry of cylinder head and piston crown). Insufficient turbulence provides low flame velocity and incomplete combustion and reduces the power output. But excessive turbulence is also not desirable as it increases the combustion rapidly and leads to detonation. Excessive turbulence causes to cool the flame generated and flame propagation is reduced. Moderate turbulence is always desirable as it accelerates the chemical reaction, reduces ignition lag, increases flame propagation and even allows weak mixture to burn efficiently.

Engine Speed

The turbulence of the mixture increases with an increase in engine speed. For this reason the flame speed almost increases linearly with engine speed. If the engine speed is doubled, flame to traverse the combustion chamber is halved. Double the original speed and half the original time give the same number of crank degrees for flame propagation. The crank angle required for the flame propagation, which is main phase of combustion will remain almost constant at all speeds. This is an important characteristic of all petrol engines.

Engine Size

Engines of similar design generally run at the same piston speed. This is achieved by using small engines having larger RPM and larger engines having smaller RPM. Due to same piston speed, the inlet velocity, degree of turbulence and flame speed are nearly same in similar engines regardless of the size. However, in small engines the flame travel is small and

in large engines large. Therefore, if the engine size is doubled the time required for propagation of flame through combustion space is also doubled. But with lower RPM of large engines the time for flame propagation in terms of crank would be nearly same as in small engines. In other words, the number of crank degrees required for flame travel will be about the same irrespective of engine size provided the engines are similar.

5. Other Factors: Among the other factors, the factors which increase the flame speed are supercharging of the engine, spark timing and residual gases left in the engine at the end of exhaust stroke. The air humidity also affects the flame velocity but its exact effect is not known. Anyhow, its effect is not large compared with A:F ratio and turbulence.

***Detonation or knocking**

Knocking is due to auto ignition of end portion of unburned charge in combustion chamber. As the normal flame proceeds across the chamber, pressure and temperature of unburned charge increase due to compression by burned portion of charge. This unburned compressed charge may auto ignite under certain temperature condition and release the energy at a very rapid rate compared to normal combustion process in cylinder. This rapid release of energy during auto ignition causes a high pressure differential in combustion chamber and a high pressure wave is released from auto ignition region. The motion of high pressure compression waves inside the cylinder causes vibration of engine parts and pinging noise and it is known as knocking or detonation. This pressure frequency or vibration frequency in SI engine can be up to 5000 Cycles per second. Denotation is undesirable as it affects the engine performance and life, as it abruptly increases sudden large amount of heat energy. It also put a limit on compression ratio at which engine can be operated which directly affects the engine efficiency and output.

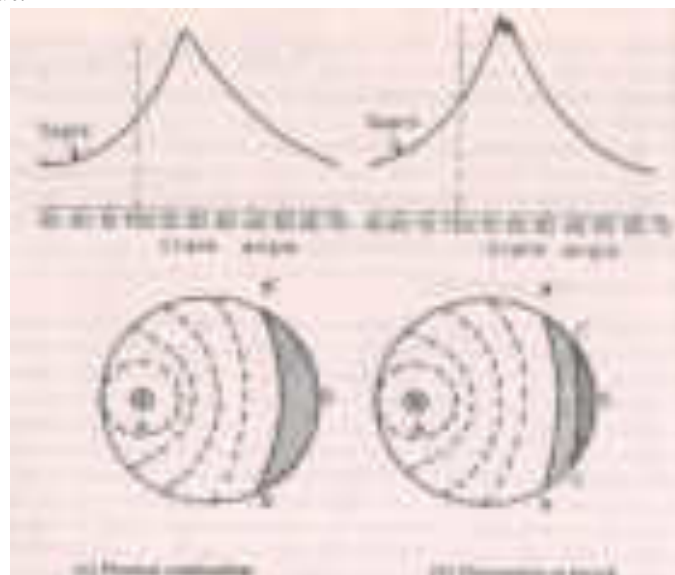

Fig. 26. Detonation in SI engine

***Auto ignition**

A mixture of fuel and air can react spontaneously and produce heat by chemical reaction in the absence of flame to initiate the combustion or self-ignition. This type of self-ignition in the absence of flame is known as Auto-Ignition. The temperature at which the self-ignition takes place is known as self-igniting temperature. The pressure and temperature abruptly increase due to auto-ignition because of sudden release of chemical energy. This auto-

ignition leads to abnormal combustion known as detonation which is undesirable because its bad effect on the engine performance and life as it abruptly increases sudden large amount of heat energy. In addition to this knocking puts a limit on the compression ratio at which an engine can be operated which directly affects the engine efficiency and output.

***Pre-ignition**

Pre-ignition is the ignition of the homogeneous mixture of charge as it comes in contact with hot surfaces, in the absence of spark. Auto ignition may overheat the spark plug and exhaust valve and it remains so hot that its temperature is sufficient to ignite the charge in next cycle during the compression stroke before spark occurs and this causes the pre-ignition of the charge. Pre-ignition is initiated by some overheated projecting part such as the sparking plug electrodes, exhaust valve head, metal corners in the combustion chamber, carbon deposits or protruding cylinder head gasket rim etc. pre-ignition is also caused by persistent detonating pressure shockwaves scoring away the stagnant gases which normally protect the combustion chamber walls. The resulting increased heat flow through the walls, raises the surface temperature of any protruding poorly cooled part of the chamber, and this therefore provides a focal point for pre-ignition.

Effects of Pre-ignition

- It increase the tendency of denotation in the engine
- It increases heat transfer to cylinder walls because high temperature gas remains in contact with for a longer time
- Pre-ignition in a single cylinder will reduce the speed and power output
- Pre-ignition may cause seizer in the multi-cylinder engines, only if only cylinders have pre-ignition

***Effect of detonation**

The harmful effects of detonation are as follows:

1. Noise and roughness: knocking produces a loud pulsating noise and pressure waves. These waves vibrate back and forth across the cylinder. The presence of vibratory motion causes crankshaft vibrations and the engine runs rough.

2. Mechanical damage:

(a) High pressure waves generated during knocking can increase rate of wear of parts of combustion chamber. Sever erosion of piston crown (in a manner similar to that of marine propeller blades by cavitation), cylinder head and pitting of inlet and outlet valves may result in complete wreckage of the engine.

(b) Detonation is very dangerous in engines having high noise level. In small engines the knocking noise is easily detected and the corrective measures can be taken but in aero-engines it is difficult to detect knocking noise and hence corrective measures cannot be taken. Hence severe detonation may persist for a long time which may ultimately result in complete wreckage of the piston.

3. Carbon deposits: Detonation results in increased carbon deposits.

4. Increase in heat transfer: Knocking is accompanied by an increase in the rate of heat transfer to the combustion chamber walls.

The increase in heat transfer is due to two reasons.

-The minor reason is that the maximum temperature in a detonating engine is about 150°C higher than in a non-detonating engine, due to rapid completion of combustion

-The major reason for increased heat transfer is the scouring away of protective layer of inactive stagnant gas on the cylinder walls due to pressure waves. The inactive layer of gas

normally reduces the heat transfer by protecting the combustion and piston crown from direct contact with flame.

5. Decrease in power output and efficiency: Due to increase in the rate of heat transfer the power output as well as efficiency of a detonating engine decreases.

6 Pre-ignition: increase in the rate of heat transfer to the walls has yet another effect. It may cause local overheating, especially of the sparking plug, which may reach a temperature high enough to ignite the charge before the passage of spark, thus causing pre-ignition. An engine detonating for a long period would most probably lead to pre-ignition and this is the real danger of detonation.

***Effect of engine operating variables on the engine knocking Detonation**

The various engine variables affecting knocking can be classified as:

- Temperature factors
- Density factors
- Time factors
- Composition factors

(a) Temperature factors:

Increasing the temperature of the unburned mixture increase the possibility of knock in SI engine, the effect of following engine parameters on the temperature of the unburned mixture:

- Raising the compression ratio: Increasing the compression ratio increases both the temperature and pressure (density of the unburned mixture). Increase in temperature reduces the delay period of the end gas which in turn increases the tendency to knock.
- Supercharging: It also increases both temperature and density, which increase the knocking tendency of engine
- Coolant temperature: Delay period decreases with increase of coolant temperature, decreased delay period increase the tendency to knock
- Temperature of the cylinder and combustion chamber walls: The temperature of the end gas depends on the design of combustion chamber. Sparking plug and exhaust valve are two hottest parts in the combustion chamber and uneven temperature leads to pre-ignition and hence the knocking.

(b) Density factors:

Increasing the density of unburnt mixture will increase the possibility of knock in the engine. The engine parameters which affect the density are as follows:

- Increased compression ratio increase the density
- Increasing the load opens the throttle valve more and thus the density
- Supercharging increase the density of the mixture
- Increasing the inlet pressure increases the overall pressure during the cycle. The high pressure end gas decreases the delay period which increase the tendency of knocking.
- Advanced spark timing: quantity of fuel burnt per cycle before and after TDC position depends on spark timing. The temperature of charge increases by increasing the spark advance and it increases with rate of burning and does not allow sufficient time to the end mixture to dissipate the heat and increase the knocking tendency

(c) Time factors:

Increasing the time of exposure of the unburned mixture to auto-ignition conditions increase the possibility of knock in SI engines.

Flame travel distance: If the distance of flame travel is more, then possibility of knocking is also more. This problem can be solved by combustion chamber design, spark plug location and engine size. Compact combustion chamber will have better anti-knock characteristics, since the flame travel and combustion time will be shorter. Further, if the combustion chamber is highly turbulent, the combustion rate is high and consequently combustion time is further reduced; this further reduces the tendency to knock.

Location of sparkplug: A spark plug which is centrally located in the combustion chamber has minimum tendency to knock as the flame travel is minimum. The flame travel can be reduced by using two or more spark plugs.

Location of exhaust valve: The exhaust valve should be located close to the spark plug so that it is not in the end gas region; otherwise there will be a tendency to knock.

Engine size: Large engines have a greater knocking tendency because flame requires a longer time to travel across the combustion chamber. In SI engine therefore, generally limited to 100mm

Turbulence of mixture: decreasing the turbulence of the mixture decreases the flame speed and hence increases the tendency to knock. Turbulence depends on the design of combustion chamber and one engine speed.

(d) Composition:

The properties of fuel and A/F ratio are primary means to control knock :

(i) Molecular Structure: The knocking tendency is markedly affected by the type of the fuel used. Petroleum fuels usually consist of many hydro-carbons of different molecular structure. The structure of the fuel molecule has enormous effect on knocking tendency. Increasing the carbon-chain increases the knocking tendency and centralizing the carbon atoms decreases the knocking tendency. Unsaturated hydrocarbons have less knocking tendency than saturated hydrocarbons.

Paraffins

- Increasing the length of carbon chain increases the knocking tendency.
- Centralising the carbon atoms decreases the knocking tendency.
- Adding methyl group (CH₃) to the side of the carbon chain in the centre position decreases the knocking tendency.

Olefins

- Introduction of one double bond has little effect on anti-knock quality but two or three double bond results less knocking tendency except C₂ and C₃

Napthenes and Aromatics

- Napthenes have greater knocking tendency than corresponding aromatics.
- With increasing double-bonds, the knocking tendency is reduced.
- Lengthening the side chains increases the knocking tendency whereas branching of the side chain decreases the knocking tendency.

(ii) Fuel-air ratio: The most important effect of fuel-air ratio is on the reaction time or ignition delay. When the mixture is nearly 10% richer than stoichiometric (fuel-air ratio =0.08) ignition lag of the end gas is minimum and the velocity of flame propagation is maximum. By making the mixture leaner or richer (than F/A 0.08) the tendency to knock is decreased. A too rich mixture is especially effective in decreasing or eliminating the knock due to longer delay and lower temperature of compression.

(iii) Humidity of air: Increasing atmospheric humidity decreases the tendency to knock by decreasing the reaction time of the fuel

***SI engine combustion chamber**

(a) T-head combustion chamber: 2 cam shaft, prone to detonation, average octane number 45-50

(b) I-head or side valve combustion chamber:

- lack of turbulence
- extremely sensitive to ignition timing
- prone to detonation

(c) F-head combustion chamber:

- Compromise between I-head and L-head

***Stages of combustion in CI engine**

1. Ignition delay period:

The period between the start of fuel injection into the combustion chamber and the start of combustion is termed as ignition delay period. The start of combustion is determined from the change in slope on p- θ diagram or from heat release analysis of the p- θ data, or from luminosity detector in experimental conditions. Start of injection can be determined by a needle-lift indicator to record the time when injector needle lifts off its seat. Start of combustion is more difficult to determine precisely. It is best identified from the change in slope of heat release rate, determined from cylinder pressure data. In DI engines ignition is well defined, in IDI engines ignition point is harder to identify

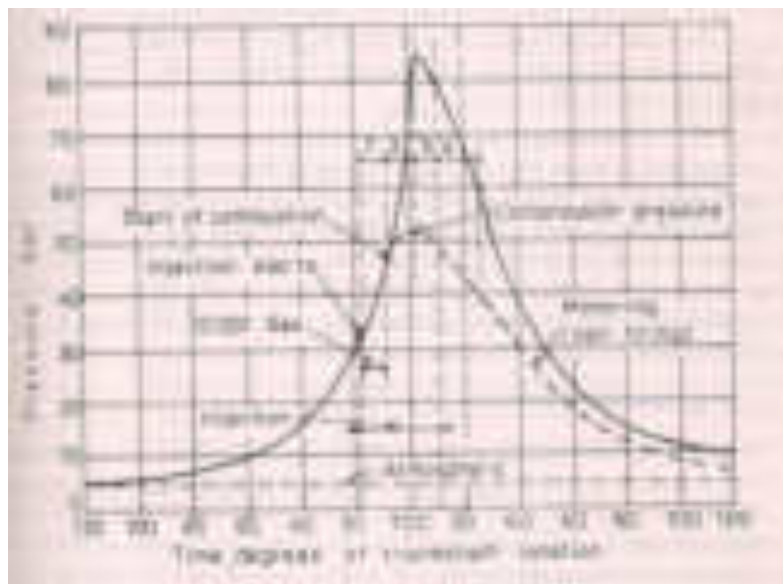

Fig. 27. Stages of combustion in CI engine

Both physical and chemical processes must take place before a significant fraction of the chemical energy of the injected liquid is released.

Physical processes are fuel spray atomization, evaporation and mixing of fuel vapour with cylinder air.

Good atomization requires high fuel-injection pressure, small injector hole, optimum fuel viscosity, high cylinder pressure (large divergence angle).

Rate of vaporization of the fuel droplets depends on droplet diameter, velocity, fuel volatility, pressure and temperature of the air.

Chemical processes similar to that described for auto ignition phenomenon in premixed fuel-air, only more complex since **heterogeneous reactions** (reactions occurring on the liquid fuel drop surface) also occur.

Chemical delay is more effective for the duration of the ignition delay period.

Ignition delay period is in the range of

0.6 to 3 ms for low-compression ratio DI diesel engines,

0.4 to 1 ms for high-compression ratio, turbocharged DI diesel engines,

0.6 to 1.5 ms for IDI diesel engines

2. Rapid or uncontrolled or pre-mixed combustion phase:

Combustion of the fuel which has mixed with air within flammability limits during ignition delay period occurs rapidly in a few crank angle degrees - high heat release characteristics in this phase. If the amount of fuel collected in the combustion chamber during the ignition delay is much - high heat release rate results in a rapid pressure rise which causes the diesel knock.

For fuels with low cetane number, with long ignition delay, ignition occurs late in the expansion stroke - incomplete combustion, reduced power output, poor fuel conversion efficiency. If the pressure gradient is in the range $0.4 - 0.5 \text{ MPa/}^\circ\text{CA}$, engine operation is not smooth and diesels knock starts. This value should be in the range 0.2 to $0.3 \text{ MPa/}^\circ\text{CA}$ for smooth operation (max allowable value is $1.0 \text{ MPa/}^\circ\text{CA}$) of the engine.

3. Controlled or diffusion combustion phase:

Once the fuel and air which is pre-mixed during the ignition delay is consumed, the burning rate (heat release rate) is controlled by the rate at which mixture becomes available for burning. The rate of burning in this phase is mainly controlled by the mixing process of fuel vapour and air. Liquid fuel atomization, vaporization, pre flame chemical reactions also affect the rate of heat release.

Heat release rate sometimes reaches a second peak (which is lower in magnitude) and then decreases as the phase progresses. Generally it is desirable to have the combustion process near the TDC for low particulate (soot) emissions and high performance (and efficiency).

4. After burning or late combustion phase:

Heat release rate continues at a lower rate into the expansion stroke -there are several reasons for this: a small fraction of the fuel may not yet burn, a fraction of the energy is present in soot and fuel-rich combustion products and can be released. The cylinder charge is non-uniform and mixing during this phase promotes more complete combustion and less dissociated product gases. Kinetics is slower.

*** Variables affecting delay period**

(i) Cetane number

Both physical and chemical properties of the fuel are important. Ignition quality of the fuel is defined by its cetane number. Straight chain paraffinic compounds (normal alkanes) have

highest ignition quality, which improves as the chain length increases. Aromatic compounds, alcohols have poor ignition quality.

-Cetane number can be increased by ignition-accelerating additives like organic peroxides, nitrates, nitrites and various sulphur compounds. Most important (commercially) is alkyl nitrates – about 0.5% by vol in a distillate fuel increase CN by 10.

-Normal diesel fuel has CN of 40 to 55 (high speed 50 – 60, low speed 25 – 45)

(ii) Injection timing

-At normal operating conditions min ignition delay (ID) occurs with start of injection at 10 to 15 °CA BTDC

-Cylinder temperature and pressure drops if injection is earlier or later (high at first but decrease as delay proceeds)

(iii) Injection quantity (load)

-Reducing engine load changes AFR, cools down the engine, reduces wall temperatures, reduces residual gas temperatures and increase ID

-Droplet size, injection velocity and rate Ignition quality within practical limits do not have significant effect on ID

-Increase in injection pressure produces only modest decrease in ID Injector nozzle diameter -effects of droplet size but has no significant effect on ID

(iv) Intake air temperature and pressure

-Reducing intake air T and p increase ID

-Strong dependence of ID on charge temperature below 1000 K – above this value effect of intake air conditions is not significant.

(v) Engine speed

Increase in engine speed increases the air motion and turbulence, reduces ID time slightly (in ms), in terms of CA degrees ID increases almost linearly.

-A change in engine speed, changes “temp~time” and “pressure~time” relationships

(vi) Combustion chamber design

-Spray impingement on the walls effect fuel evaporation and ID increase in compression ratio, increase p and T and reduces ID

-Reducing stroke volume, increase surface area to volume ratio, increase engine cooling and increase ID

(vii) Swirl rate

-Change of evaporation rate and air-fuel mixing - under normal operating conditions the effect is small.

-At start-up (low engine speed and temperature) more important, high rate of evaporation and mixing is obtained by swirl

(viii) Oxygen concentration

Residual gases reduce O₂ concentration and reducing oxygen concentration increases ID

***Diesel knock**

-CI engine detonation occurs in the beginning of combustion

-In CI engine the fuel and air are imperfectly mixed and hence the rate of pressure rise is normally cause audible knock. Rate of pressure rise may reach as high as 10 bar/°CA

- High engine vibration is the symptoms of knocking
- no pre-ignition or premature ignition as like SI engine

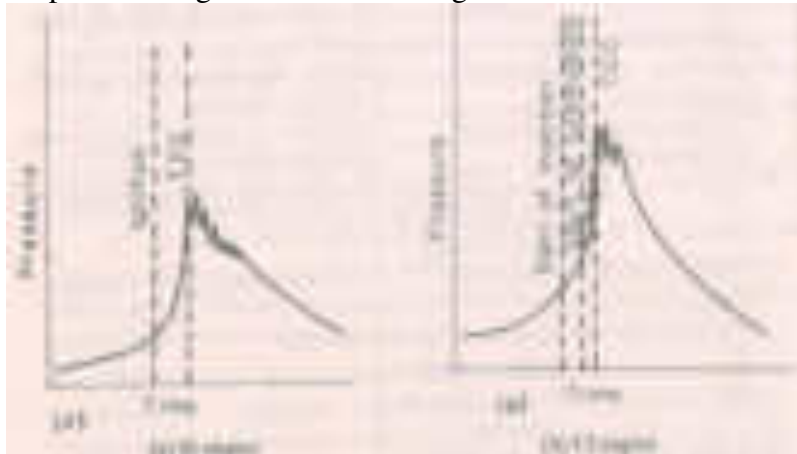

Fig. 28. Detonation in SI and CI engine

***Combustion chamber**

(i) According to the swirl of air

- (a) Induction swirl or open chamber or non-turbulent chamber
- (b) Compression swirl
- (c) Combustion induced swirl

(ii) According to speed of the engine

(a) Low speed engine ($n < 1500$ rpm):

- Shallow, swirl-less combustion chambers
- Direct, multi-jet fuel injection

(b) Medium speed engine ($n = 1500-3000$ rpm):

- Deep combustion chambers with intensive swirl of charge
- Direct injection of atomised fuel

(c) high speed engine ($n = 3000-5000$ rpm):

- Pre-chambers (sectional combustion chambers)
- Indirect injection of fuel into the pre-chamber

Module-III

TESTING AND PERFORMANCE

Engine performance is an indication of the degree of success of the engine performs its assigned task, i.e. the conversion of the chemical energy contained in the fuel into the useful mechanical work. The performance of an engine is evaluated on the basis of the following;

- (a) Specific Fuel Consumption.
- (b) Brake Mean Effective Pressure.
- (c) Specific Power Output.
- (d) Specific Weight.
- (e) Exhaust Smoke and Other Emissions.

Basic measurements:

The basic measurements to be undertaken to evaluate the performance of an engine on almost all tests are the following:

- (a) Speed
- (b) Fuel consumption
- (c) Air consumption
- (d) Smoke density
- (e) Brake horse-power
- (f) Indicated horse power and friction horse power
- (g) Heat balance sheet or performance of SI and CI engine
- (h) Exhaust gas analysis

1. Measurement of speed:

-One of the basic measurements is that of speed. A wide variety of speed measuring devices are available in the market. They range from a mechanical tachometer to digital and triggered electrical tachometers.

-The best method of measuring speed is to count the number of revolutions in a given time. This gives an accurate measurement of speed. Many engines are fitted with such revolution counters.

-A mechanical tachometer or an electrical tachometer can also be used for measuring the speed.

-The electrical tachometer has a three-phase permanent-magnet alternator to which a voltmeter is attached. -The output of the alternator is a linear function of the speed and is directly indicated on the voltmeter dial.

-Both electrical and mechanical types of tachometers are affected by the temperature variations and are not very accurate. For accurate and continuous measurement of speed a magnetic pick-up placed near a toothed wheel coupled to the engine shaft can be used.

-The magnetic pick-up will produce a pulse for every revolution and a pulse counter will accurately measure the speed.

2. Fuel consumption measurement:

Fuel consumption is measured in two ways:

- (a) The fuel consumption of an engine is measured by determining the volume flow in a given time interval and multiplying it by the specific gravity of the fuel which should be measured occasionally to get an accurate value.
- (b) Another method is to measure the time required for consumption of a given mass of fuel.

As already mentioned two basic types of fuel measurement methods are:

-Volumetric type

-Gravimetric type

Volumetric type flow meter includes Burette method, Automatic Burette flow meter and Turbine flow meter.

Gravimetric Fuel Flow Measurement

The efficiency of an engine is related to the kilograms of fuel which are consumed and not the number of litres. The method of measuring volume flow and then correcting it for specific gravity variations is quite inconvenient and inherently limited in accuracy. Instead if the weight of the fuel consumed is directly measured a great improvement in accuracy and cost can be obtained. There are three types of gravimetric type systems which are commercially available include Actual weighing of fuel consumed, Four Orifice Flow meter, etc.

3. Measurement of air consumption:

In IC engines, the satisfactory measurement of air consumption is quite difficult because the flow is pulsating, due to the cyclic nature of the engine and because the air a compressible fluid. Therefore, the simple method of using an orifice in the induction pipe is not satisfactory since the reading will be pulsating and unreliable.

All kinetic flow-infering systems such as nozzles, orifices and venturies have a square law relationship between flow rate and differential pressure which gives rise to severe errors on unsteady flow. Pulsation produced errors are roughly inversely proportional to the pressure across the orifice for a given set of flow conditions. The various methods and meters used for air flow measurement include,

(a) Air box method, and

(b) Viscous-flow air meter

4. Measurement of brake power:

The brake power measurement involves the determination of the torque and the angular speed of the engine output shaft. The torque measuring device is called a dynamometer.

Dynamometers can be broadly classified into two main types, power absorption dynamometers and transmission dynamometer.

Absorption Dynamometers

These dynamometers measure and absorb the power output of the engine to which they are coupled. The power absorbed is usually dissipated as heat by some means. Example of such dynamometers is prony brake, rope brake, hydraulic dynamometer, etc.

Transmission Dynamometers

In transmission dynamometers, the power is transmitted to the load coupled to the engine after it is indicated on some type of scale. These are also called torque-meters.

(a) Prony brake dynamometer

One of the simplest methods of measuring brake power (output) is to attempt to stop the engine by means of a brake on the flywheel and measure the weight which an arm attached to the brake will support, as it tries to rotate with the flywheel.

It consists of wooden block mounted on a flexible rope or band the wooden block when pressed into contact with the rotating drum takes the engine torque and the power is dissipated in frictional resistance. Spring-loaded bolts are provided to tighten the wooden block and hence increase the friction.

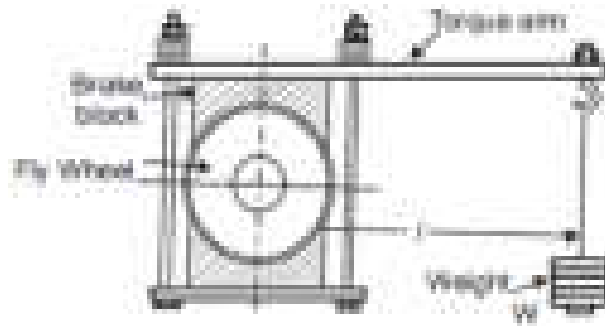

Fig. 29. Prony brake

The whole of the power absorbed is converted into heat and hence this type of dynamometer must be cooled. The brake horsepower is given by

$$BP = 2\pi NT$$

where, $T = W \times l$

W being the weight applied at a radius l .

(b) Rope brake

It consists of a number of turns of rope wound around the rotating drum attached to the output shaft. One side of the rope is connected to a spring balance and the other to a loading device. The power is absorbed in friction between the rope and the drum. The drum therefore requires cooling.

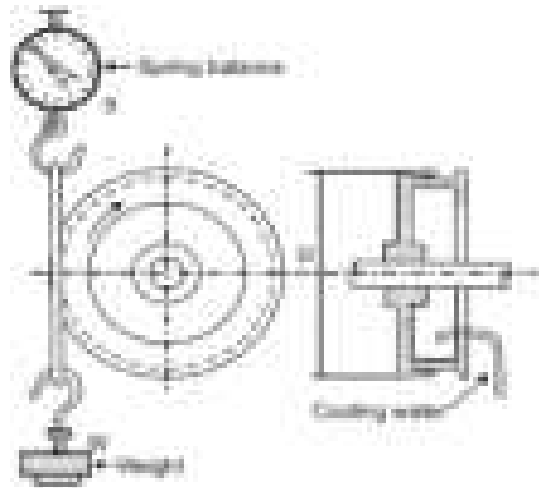

Fig. 30. Rope brake

Rope brake is cheap and easily constructed but not a very accurate method because of changes in the friction coefficient of the rope with temperature.

The bp is given by

$$bp = \pi DN (W - S)$$

where, D is the brake drum diameter, W is the weight in Newton and S is the spring scale reading.

(c) Hydraulic Dynamometer

Hydraulic dynamometer works on the principle of dissipating the power in fluid friction rather than in dry friction.

- In principle its construction is similar to that of a fluid flywheel.
- It consists of an inner rotating member or impeller coupled to the output shaft of the engine.
- This impeller rotates in a casing filled with fluid.
- This outer casing, due to the centrifugal force developed, tends to revolve with the impeller, but is resisted by a torque arm supporting the balance weight.

- The frictional forces between the impeller and the fluid are measured by the spring-balance fitted on the casing.
- The heat developed due to dissipation of power is carried away by a continuous supply of the working fluid, usually water.
- The output can be controlled by regulating the sluice gates which can be moved in and out to partially or wholly obstruct the flow of water between impeller, and the casing.

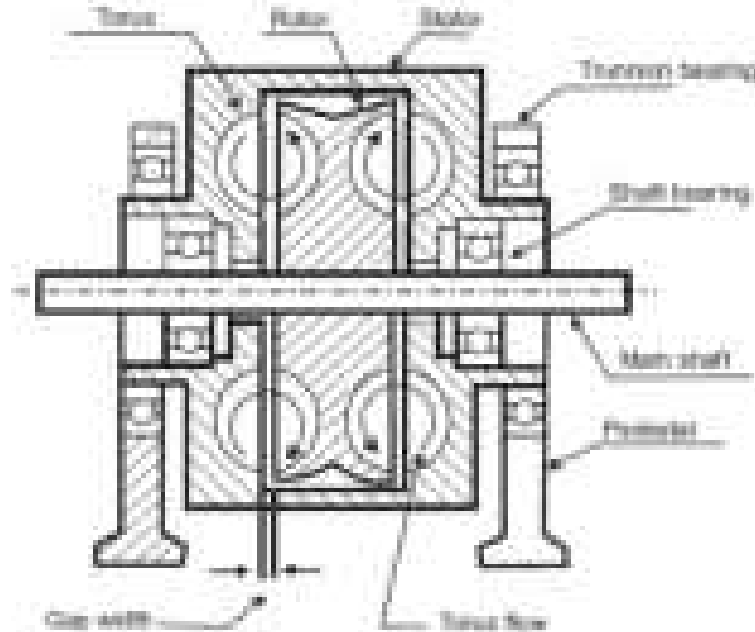

Fig. 31. Hydraulic dynamometer

(d) Eddy Current Dynamometer

It consists of a stator on which are fitted a number of electromagnets and a rotor disc made of copper or steel and coupled to the output shaft of the engine. When the rotor rotates eddy currents are produced in the stator due to magnetic flux set up by the passage of field current in the electromagnets. These eddy currents are dissipated in producing heat so that this type of dynamometer also requires some cooling arrangement. The torque is measured exactly as in other types of absorption dynamometers, i.e. with the help of a moment arm. The load is controlled by regulating the current in the electromagnets.

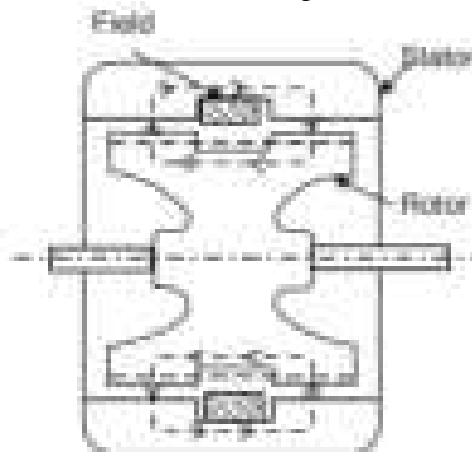

Fig. 32. Eddy current dynamometer

The following are the main advantages of eddy current dynamometer:

- (a) High brake power per unit weight of dynamometer.

- (b) They offer the highest ratio of constant power speed range (up to 5 : 1).
- (c) Level of field excitation is below 1% of total power being handled by dynamometer, thus, easy to control and programme.
- (d) Development of eddy current is smooth hence the torque is also smooth and continuous under all conditions.
- (e) Relatively higher torque under low speed conditions.
- (f) It has no intricate rotating parts except shaft bearing.
- (g) No natural limit to size-either small or large.

(e) Swinging Field d.c. Dynamometer

Basically, a swinging field d.c. dynamometer is a d.c. shunt motor so supported on trunnion bearings to measure their action torque that the outer case and filed coils tend to rotate with the magnetic drag. Hence, the name swinging field. The torque is measured with an arm and weighing equipment in the usual manner.

Many dynamometers are provided with suitable electric connections to run as motor also. Then the dynamometer is reversible, i.e. works as motoring as well as power absorbing device.

-When used as an absorption dynamometer it works as a d.c. generator and converts mechanical energy into electric energy which is dissipated in an external resistor or fed back to the mains.

-When used as a motoring device an external source of d.c. voltage is needed to drive the motor.

The load is controlled by changing the field current.

Fan Dynamometer

It is also an absorption type of dynamometer in that when driven by the engine it absorbs the engine power. Such dynamometers are useful mainly for rough testing and running. The accuracy of the fan dynamometer is very poor. The power absorbed is determined by using previous calibration of the fan brake.

Transmission Dynamometers

Transmission dynamometers, also called torque meters, mostly consist of a set of strain-gauges fixed on the rotating shaft and the torque is measured by the angular deformation of the shaft which is indicated as strain of the strain gauge. Usually, a four arm bridge is used to reduce the effect of temperature to minimum and the gauges are arranged in pairs such that the effect of axial or transverse load on the strain gauges is avoided.

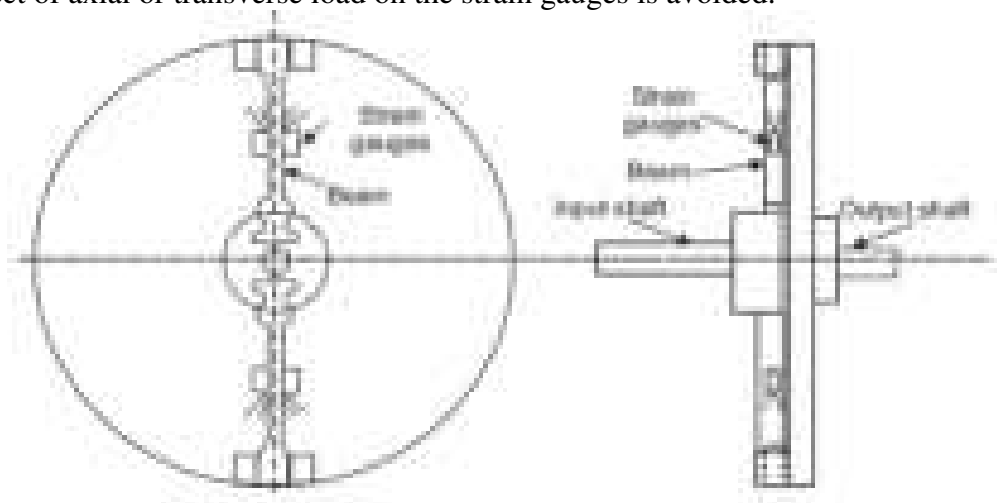

Fig. 33. Transmission dynamometer

Transmission dynamometers are very accurate and are used where continuous transmission of load is necessary. These are used mainly in automatic units.

5. Measurement of friction power:

- The difference between indicated power and the brake power output of an engine is the friction power.
- Almost invariably, the difference between a good engine and a bad engine is due to difference between their frictional losses.
- The frictional losses are ultimately dissipated to the cooling system (and exhaust) as they appear in the form of frictional heat and this influences the cooling capacity required. Moreover, lower friction means availability of more brake power; hence brake specific fuel consumption is lower.
- The *bsfc* rises with an increase in speed. Thus, the level of friction decides the maximum output of the engine which can be obtained economically.

The friction force power of an engine is determined by the following methods :

- (a) Willan's line method.
- (b) Morse test.
- (c) Motoring test.
- (d) Difference between *ip* and *bp*.

(a) Willan's line method

- In this method, gross fuel consumption vs. *bp* at a constant speed is plotted and the graph is extrapolated back to zero fuel consumption.
- The point where this graph cuts the *bp* axis is an indication of the friction power of the engine at that speed. This negative work represents the combined loss due to mechanical friction, pumping and blow by.
- The main drawback of this method is the long distance to be extrapolated from data measured between 5 and 40% load towards the zero line of fuel input.
- The directional margin of error is rather wide because of the graph which may not be a straight line many times.
- The changing slope along the curve indicates part efficiencies of increments of fuel. The pronounced change in the slope of this line near full load reflects the limiting influence of the air-fuel ratio and of the quality of combustion.
- Similarly, there is a slight curvature at light loads. This is perhaps due to difficulty in injecting accurately and consistently very small quantities of fuel per cycle.
- Therefore, it is essential that great care should be taken at light loads to establish the true nature of the curve.
- The Willan's line for a swirl-chamber CI engine is straighter than that for a direct injection type engine.

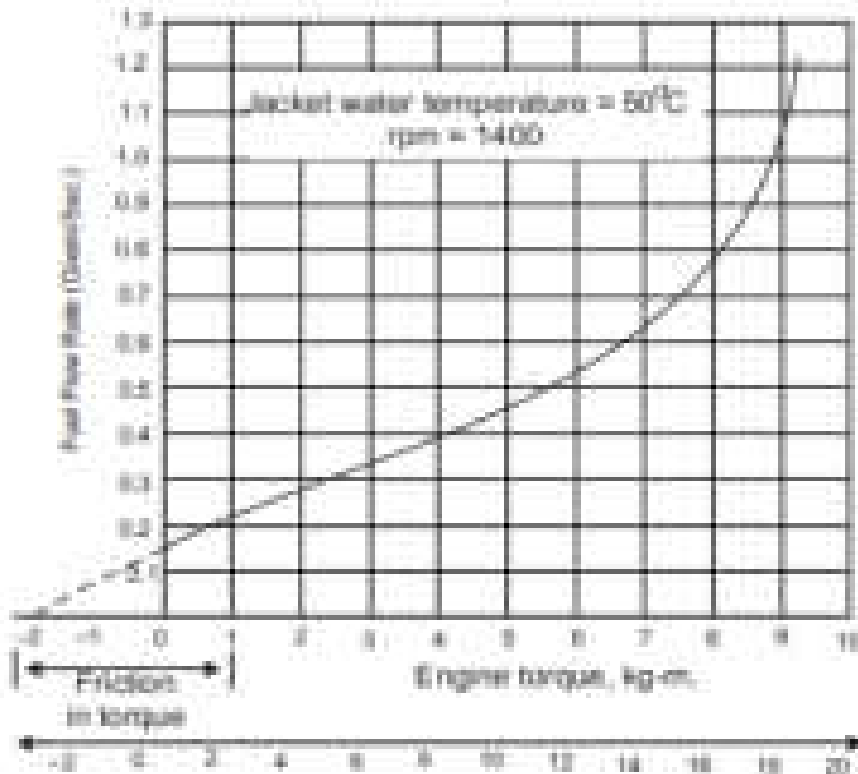

Fig. 34. Willian's line method

The accuracy obtained in this method is good and compares favourably with other methods if extrapolation is carefully done.

(b) Morse Test

- The Morse test is applicable only to multicylinder engines.
- In this test, the engine is first run at the required speed and the output is measured.
- Then, one cylinder is cut out by short circuiting the spark plug or by disconnecting the injector as the case may be.
- Under this condition all other cylinders 'motor' this cut-out cylinder.
- The output is measured by keeping the speed constant at its original value.
- The difference in the outputs is a measure of the indicated horse power of the cut-out cylinder.
- Thus, for each cylinder the *ip* is obtained and is added together to find the total *ip* of the engine.
- This method though gives reasonably accurate results and is liable to errors due to changes in mixture distribution and other conditions by cutting-out one cylinder. In gasoline engines, where there is a common manifold for two or more cylinders the mixture distribution as well as the volumetric efficiency both change. Again, almost all engines have a common exhaust manifold for all cylinders and cutting out of one cylinder may greatly affect the pulsations in exhaust system which may significantly change the engine performance by imposing different back pressures.

(c) Motoring Test

- In the motoring test, the engine is first run up to the desired speed by its own power and allowed to remain at the given speed and load conditions for some time so that oil, water, and engine component temperatures reach stable conditions.
- The power of the engine during this period is absorbed by a swinging field type electric dynamometer, which is most suitable for this test.

-The fuel supply is then cut-off and by suitable electric-switching devices the dynamometer is converted to run as a motor to drive for 'motor' the engine at the same speed at which it was previously running.

-The power supply to the motor is measured which is a measure of the fhp of the engine. During the motoring test the water supply is also cut-off so that the actual operating temperatures are maintained.

-This method, though determines the fp at temperature conditions very near to the actual operating temperatures at the test speed and load, does, not give the true losses occurring under firing conditions due to the following reasons.

(i) The temperatures in the motored engine are different from those in a firing engine because even if water circulation is stopped the incoming air cools the cylinder. This reduces the lubricating oil temperature and increases friction increasing the oil viscosity. This problem is much more severing in air-cooled engines.

(ii) The pressure on the bearings and piston rings is lower than the firing pressure. Load on main and connecting rod bearings are lower.

(iii) The clearance between piston and cylinder wall is more (due to cooling). This reduces the piston friction.

(iv) The air is drawn at a temperature less than when the engine is firing because it does not get heat from the cylinder (rather loses heat to the cylinder). This makes the expansion line to be lower than the compression line on the p-v diagram. This loss is however counted in the indicator diagram.

(v) During exhaust the back pressure is more because under motoring conditions sufficient pressure difference is not available to impart gases the kinetic energy is necessary to expel them from exhaust.

Motoring method, however, gives reasonably good results and is very suitable for finding the losses due to various engine components. This insight into the losses caused by various components and other parameters is obtained by progressive stripping-off of the under progressive dismantling conditions keeping water and oil circulation intact. Then the cylinder head can be removed to evaluate, by difference, the compression loss. In this manner piston ring, piston etc. can be removed and evaluated for their effect on overall friction.

(d) Difference between ip and bp

(i) The method of finding the fp by computing the difference between ip , as obtained from an indicator diagram, and bp , as obtained by a dynamometer, is the ideal method.

(ii) In obtaining accurate indicator diagrams, especially at high engine speeds, this method is usually only used in research laboratories. Its use at commercial level is very limited.

6. Heat balance sheet:

The performance of an engine is usually studied by heat balance-sheet. The main components of the heat balance are:

-Heat equivalent to the effective (brake) work of the engine,

-Heat rejected to the cooling medium,

-Heat carried away from the engine with the exhaust gases, and

-Unaccounted losses.

The unaccounted losses include the radiation losses from the various parts of the engine and heat lost due to incomplete combustion. The friction loss is not shown as a separate item to the heat balance-sheet as the friction loss ultimately reappears as heat in cooling water, exhaust and radiation.

(i) Performance of SI engine:

-At full throttle the brake thermal efficiency at various speeds varies from 20 to 27 percent, maximum efficiency being at the middle speed range.

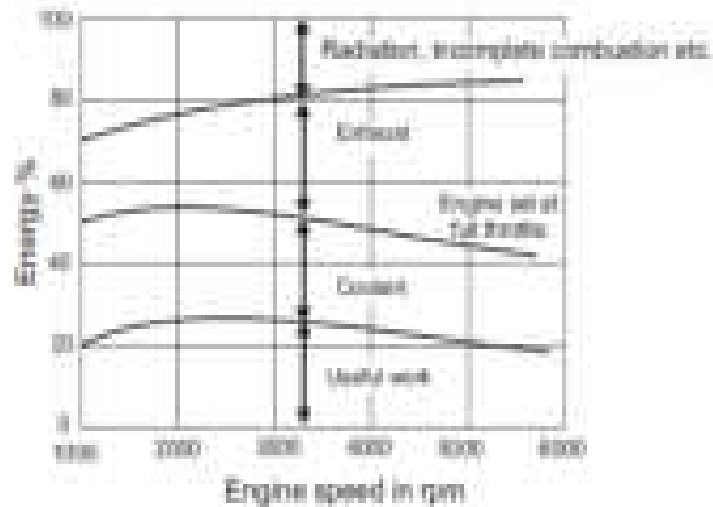

Fig. 35. Heat balance sheet for SI engine

-The percentage heat rejected to coolant is more at lower speed ($\gg 35\%$) and reduces at higher speeds ($\gg 25\%$). Considerably more heat is carried by exhaust at higher speeds.

-Torque and mean effective pressure do not strongly depend on the speed of the engine, but depend on the volumetric efficiency and friction losses. Maximum torque position corresponds with the maximum air charge or minimum volumetric efficiency position.

-High power arises from the high speed. In the speed range before the maximum power is obtained, doubling the speed doubles the power.

-At low engine speed the friction power is relatively low and bhp is nearly as large as ip . As engine speed increases, however, fp increases at continuously greater rate and therefore bp reaches a peak and starts reducing even though ip is rising. At engine speeds above the usual operating range, fp increases very rapidly. Also, at these higher speeds ip will reach a maximum and then fall off. At some point, ip and fp will be equal, and bp will then drop to zero.

(ii) Performance of CI engine:

The performance of a CI engine at constant speed and variable load is given as,

As the efficiency of CI engine is more than the SI engine the total losses are less. The coolant loss is more at low loads and radiation, etc. losses are more at high loads.

-The $b MEP$, bp and torque directly increase with load

-The lowest brake specific fuel consumption and hence the maximum efficiency occurs at about 80% of the full load.

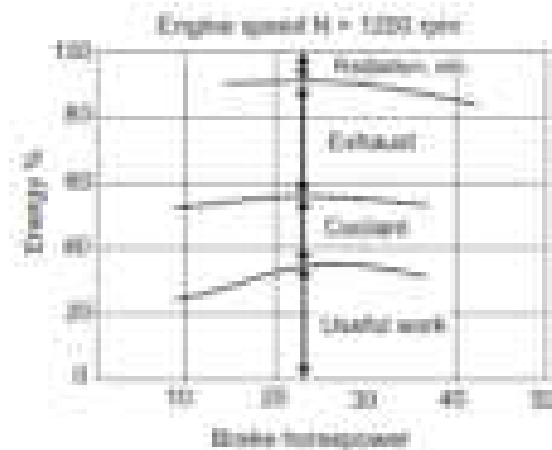

Fig. 36. Heat balance sheet of CI engine at constant speed

ENGINE COOLING

In a SI engine, cooling must be satisfactory to avoid pre-ignition and knock. In a compression ignition engine, since a normal combustion is aided, cooling must be sufficient to allow the parts to operate properly. In short, cooling is a matter of equalization of internal temperature to prevent local overheating as well as to remove sufficient heat energy to maintain a practical overall working temperature.

***Requirements of cooling system in the IC engine**

The cooling system is provided in the IC engine for the following reasons:

-The temperature of the burning gases in the engine cylinder reaches up to 1500 to 2000°C, which is above the melting point of the material of the cylinder body and head of the engine. (Platinum, a metal which has one of the highest melting points, melts at 1750 °C, iron at 1530°C and aluminium at 657°C.) Therefore, if the heat is not dissipated, it would result in the failure of the cylinder material.

-Due to very high temperatures, the film of the lubricating oil will get oxidized, thus producing carbon deposits on the surface. This will result in piston seizure.

-Due to overheating, large temperature differences may lead to a distortion of the engine components due to the thermal stresses set up. This makes it necessary for, the temperature variation to be kept to a minimum.

-Higher temperatures also lower the volumetric efficiency of the engine.

Effect of overcooling:

-Thermal efficiency is decreased due to more loss of heat carried by the coolant

-The vaporization of the fuel is less resulting in lower combustion efficiency

-Low temperature increases the viscosity of lubricant causing more loss due to friction

There are mainly two types of cooling systems:

- (a) Air cooled system, and
- (b) Water cooled system

Air Cooled System:

-Air cooled system is generally used in small engines say up to 15-20 kW and in aero plane engines.

-In this system fins or extended surfaces are provided on the cylinder walls, cylinder head, etc. Heat generated due to combustion in the engine cylinder will be conducted to the fins and when the air flows over the fins, heat will be dissipated to air.

-The amount of heat dissipated to air depends upon:

- (a) Amount of air flowing through the fins
- (b) Fin surface area
- (c) Thermal conductivity of metal used for fins

-For efficient cooling the length of the fins and the spacing between them is quite important

-Larger inter spacing between the fins offers larger area for cooling air but the heating of the air is less, so more cooling air is required

-Smaller inter spacing between the fins results in smaller flow area of cooling air and hence input cooling air is less

-Usually fin height varies from 15 to 25 mm

Advantages of air cooled engines

Air cooled engines have the following advantages:

1. Its design of air-cooled engine is simple.
2. It is lighter in weight than water-cooled engines due to the absence of water jackets, radiator, circulating pump and the weight of the cooling water.
3. It is cheaper to manufacture.
4. It needs less care and maintenance.
5. This system of cooling is particularly advantageous where there are extreme climatic conditions in the arctic or where there is scarcity of water as in deserts.
6. No risk of damage from frost, such as cracking of cylinder jackets or radiator water tubes.

Disadvantages of air cooled engines

-Relatively large amount of power is used to drive the cooling fan.TM

-Engines give low power output.TM

-Cooling fins under certain conditions may vibrate and amplify the noise level.

-Cooling is not uniform.TM

-Engines are subjected to high working temperature.

Water cooling system:

Cooling water jackets are provided around the cylinder, cylinder head, valve seats etc. The water when circulated through the jackets, it absorbs heat of combustion. This hot water will then be cooling in the radiator partially by a fan and partially by the flow developed by the forward motion of the vehicle. The cooled water is again recirculated through the water jackets.

Antifreeze mixture

In western countries if the water used in the radiator freezes because of cold climates, then ice formed has more volume and produces cracks in the cylinder blocks, pipes, and radiator. So, to prevent freezing antifreeze mixtures or solutions are added in the cooling water.

Normally following are used as antifreeze solutions:

- (i) Methyl, ethyl and isopropyl alcohols
- (ii) A solution of alcohol and water
- (iii) Ethylene Glycol raises the boiling temperature substantially and hence more heat dissipation
- (iv) A solution of water and Ethylene Glycol
- (v) Glycerin along with water, etc.
- (vi) Chromates are used to prevent deposit

Water cooling system mainly consists of:

- Radiator
- Thermostat valve
- Water pump
- Fan
- Water Jackets
- Antifreeze mixtures

Various types of water cooling systems are given as;

- (a) Thermo-syphon cooling
- (b) Forced or pump cooling
- (c) Cooling with thermostatic regulator
- (d) Pressurised water cooling system
- (e) Evaporative cooling

(a) Thermo-syphon cooling:

This system works on the principle that hot water being lighter rises up and the cold water being heavier goes down. In this system the radiator is placed at a higher level than the engine for the easy flow of water towards the engine. Heat is conducted to the water jackets from where it is taken away due to convection by the circulating water. As the water jacket becomes hot, it rises to the top of the radiator. Cold water from the radiator takes the place of the rising hot water and in this way a circulation of water is set up in the system. This helps in keeping the engine at working temperature.

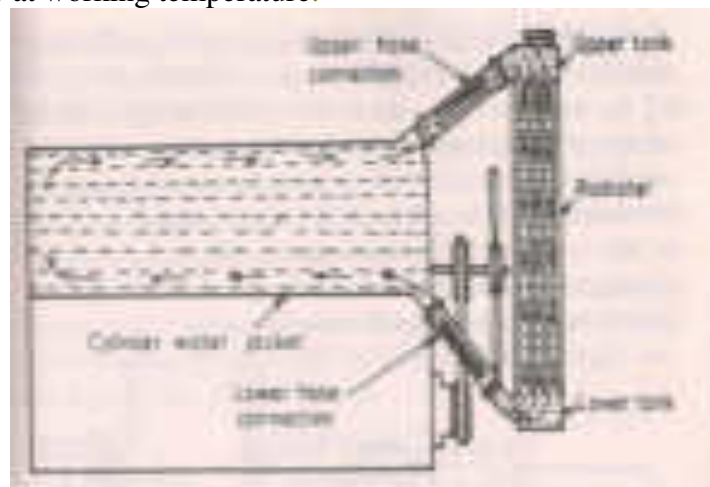

Fig. 37. Thermo-syphon cooling

Disadvantages of Thermo-syphon system,

- Rate of circulation is too slow.

- Circulation commences only when there is a marked difference in temperature.
- Circulation stops as the level of water falls below the top of the delivery pipe of the radiator. For these reasons this system has become obsolete and is no more in use.

(b) Forced or pump cooling:

- This system is used in large number of vehicles like car, buses, trucks and other heavy vehicles. Here circulation of water takes place with convection currents help by a pump.
- The water or coolant is circulated through jackets around the parts of the engine to be cooled, and is kept in motion by a centrifugal pump, driven from the engine through V-belt.

Limitation

- Cooling is independent of temp.
- Engine is overcooled (when range of temp.=75-90⁰C)
- Can be overcome by using thermostat

(c) Cooling with thermostatic regulator:

- Whenever the engine is started from cold, the coolant temperature has to be brought to the desired warm up time to avoid corrosion damage due to condensation of acids as well as help in easy starting of the engine. This can be done by the use of thermostatic device or thermostat.
- It is a kind of check valve which opens and closes with the effect of temperature. It is fitted in the water outlet of the engine. During the warm-up period, the thermostat is closed and the water pump circulates the water only throughout the cylinder block and cylinder head. When the normal operating temperature is reached, the thermostat valve opens and allows hot water to flow towards the radiator. Standard thermostats are designed to start opening at 70 to 75°C and they fully open at 82°C. High temperature thermostats, with permanent anti-freeze solutions (Prestine, Zerex, etc.), start opening at 80 to 90°C and fully open at 92°C.
- There are three types of thermostats: (i) bellow type, (ii) bimetallic type and (iii) wax type.

Bellow type valve: Flexible bellows are filled with alcohol or ether. When the bellows is heated, the liquid vaporises, creating enough pressure to expand the bellows. When the unit is cooled, the gas condenses. The pressure reduces and the bellows collapse to close the valve.

Bimetallic type valve: This consists of a bimetallic strip. The unequal expansion of two metallic strips causes the valve to open and allows the water to flow in the radiator.

Wax type valve:

- Can operate reliably within the specified temperature range
- Heat is transmitted to wax, which has high coefficient of thermal expansion
- Upon being heated, wax expands and the rubber plug presses the plunger forcing it to move vertically upwards

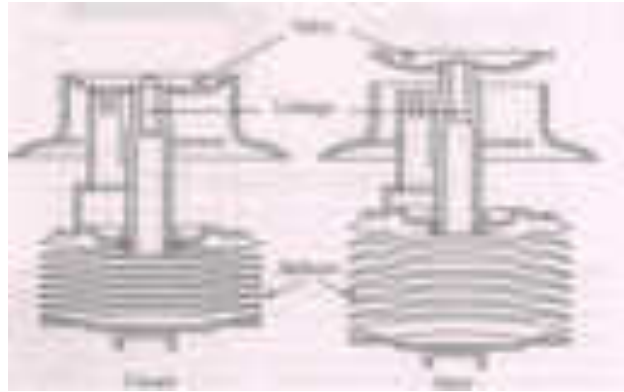

Fig. 38. Bellows type thermostat

(d) Pressurised water cooling system:

In the case of the ordinary water-cooling system where the cooling water is subjected to atmospheric pressure, the water boils at 212°F. But, when water is heated in a closed radiator under high pressure, the boiling temperature of water increases. The higher water temperature gives more efficient engine performance and affords additional protection under high altitude and tropical conditions for long hard driving periods. Therefore, a pressure-type radiator cap is used with the forced circulation cooling system. The cap is fitted on the radiator neck with an air tight seal. The pressure-release valve or safety valve is set to open at a pressure between 4 and 13 psi. With this increase in pressure, the boiling temperature of water increases to 243°F (at 4 psi boiling tap 225°F and 13 psi boiling temperature 243°F). Any increase in pressure is released by the pressure release valve or safety valve to the atmosphere. On cooling, the vapours will condense and a partial vacuum will be created which will result in the collapse of the hoses and tubes. To overcome this problem the pressure release valve is associated with a vacuum valve which opens the radiator to the atmosphere.

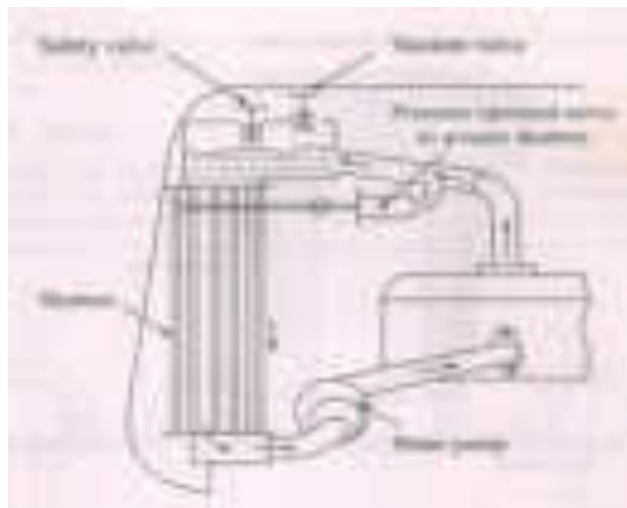

Fig. 39. Pressurised system

(e) Evaporative cooling system:

-In this system, the engine will be cooled because of the evaporation of the water in the cylinder jackets into steams.

-The advantage is being taken from the high latent heat of vaporization of water by allowing it to evaporate in the cylinder jackets. This system is used for cooling of many types of industrial engines

Descriptions of different parts of water cooling systems

Radiator: The purpose of the radiator is to cool down the water received from the engine. The radiator consists of three main parts: (i) upper tank, (ii) lower tank and (iii) tubes.

Hot water from the upper tank, which comes from the engine, flows downwards through the tubes. The heat contained in the hot water is conducted to the copper fins provided around the tubes. An overflow pipe, connected to the upper tank, permits excess water or steam to escape.

There are three types of radiators: (i) gilled tube radiator, (ii) tubular radiator and (iii) honey comb or cellular radiator

Gilled tube radiator:

This is perhaps the oldest type of radiator, although it is still in use. In this, water flows inside the tubes. Each tube has a large number of annular rings or fins pressed firmly over its outside surface.

Tubular radiator: The only difference between a gilled tubes radiator and a tubular one is that in this case there are no separate fins for individual tubes. The radiator vertical tubes pass through thin fine copper sheets which run horizontally.

Honey comb or cellular radiator: The cellular radiator consists of a large number of individual air cells which are surrounded by water. In this, the clogging of any passage affects only a small part of the cooling surface. However, in the tubular radiator, if one tube becomes clogged, the cooling effect of the entire tube is lost.

Water Pump:

This is a centrifugal type pump. It is centrally mounted at the front of the cylinder block and is usually driven by means of a belt. This type of pump consists of the following parts: (i) body or casing, (ii) impeller (rotor), (iii) shaft, (iv) bearings, or bush, (v) water pump seal and (vi) pulley.

The bottom of the radiator is connected to the suction side of the pump. The power is transmitted to the pump spindle from a pulley mounted at the end of the crankshaft. Seals of various designs are incorporated in the pump to prevent loss of coolant from the system.

Fan:

The fan is generally mounted on the water pump pulley, although on some engines it is attached directly to the crankshaft. It serves two purposes in the cooling system of an engine.

(i) It draws atmospheric air through the radiator and thus increases the efficiency of the radiator in cooling hot water.

(ii) It throws fresh air over the outer surface of the engine, which takes away the heat conducted by the engine parts and thus increases the efficiency of the entire cooling system.

***Advantages of water cooling system**

-Because of even cooling of cylinder barrel and head (due to jacketing) makes it possible to reduce the cylinder head and valve seat temperatures.

-The volumetric efficiency of water cooled engines is higher than that of air-cooled engines.

-Compact design of engines with appreciably smaller frontal area is possible.

-In case of water cooled engines, installation is not necessarily at the front of the mobile vehicles, aircraft etc. as the cooling system can be conveniently located.

***Disadvantages of water cooling system**

- The system requires more maintenance.
- The engine performance becomes sensitive to climatic conditions. TM
- The power absorbed by the pump is considerable and affects the power output of the engine. TM
- In the event of failure of the cooling system serious damage may be caused to the engine.

LUBRICATION SYSTEM

IC engine is made of many moving parts. Due to continuous movement of two metallic surfaces over each other, there is wearing moving parts, generation of heat and loss of power in the engine. Hence, lubrication of moving parts is essential to prevent all these harmful effects.

In engine the frictional losses is attributed due to the following mechanical losses;

(i) Direct frictional losses:

-power absorbed due to the relative motion of different bearing surfaces such as piston rings, main bearings, cam shaft bearings etc.

(ii) Pumping loss:

-net power spent by the piston on the gas during intake and exhaust stroke
-more in case of four stroke engine compared to two stroke engine

(iii) Power loss to drive components to charge and scavenge:

-In four stroke supercharged engine, compressor used to provide high pressure air which is mechanically driven by the engine. This is counted as negative frictional loss.
-In two-stroke engine scavenging pump is used which is also driven by the engine

(iv) Power loss to drive the auxiliaries:

-Some power is used to drive auxiliaries such as water pump, lubricating oil pump, fuel pump, cooling fan, generator etc.

Function of lubrication:

Lubrication produces the following effects: (a) Reducing friction effect (b) Cooling effect (c) Sealing effect and (d) Cleaning effect.

(a) Reducing frictional effect: The primary purpose of the lubrication is to reduce friction and wear between two rubbing surfaces. Two rubbing surfaces always produce friction. The continuous friction produce heat which causes wearing of parts and loss of power. In order to avoid friction, the contact of two sliding surfaces must be reduced as far as possible. This can be done by proper lubrication only. Lubrication forms an oil film between two moving surfaces. Lubrication also reduces noise produced by the movement of two metal surfaces over each other.

(b) Cooling effect: The heat, generated by piston, cylinder, and bearings is removed by lubrication to a great extent. Lubrication creates cooling effect on the engine parts.

(c) Sealing effect: The lubricant enters into the gap between the cylinder liner, piston and piston rings. Thus, it prevents leakage of gases from the engine cylinder.

(d) Cleaning effect: Lubrication keeps the engine clean by removing dirt or carbon from inside of the engine along with the oil.

Lubrication theory: There are two theories in existence regarding the application of lubricants on a surface: (i) Fluid film theory and (ii) Boundary layer theory.

(i) Fluid film theory: According to this theory, the lubricant is, supposed to act like mass of globules, rolling in between two surfaces. It produces a rolling effect, which reduces friction.

(ii) Boundary layer theory: According to this theory, the lubricant is soaked in rubbing surfaces and forms oily surface over it. Thus the sliding surfaces are kept apart from each other, thereby reducing friction.

Properties of Lubricant:

1. Viscosity: Viscosity is a measure of the resistance to flow or the internal friction of the lubricant.

-usually measured by Saybolt universal seconds (SUS) and Redwood viscometer. Also it is expressed with centistoke (unit of kinematic viscosity) and centipoise (unit of absolute viscosity)

-expressed in two temperature i.e. -18°C (0°F) and 99°C (210°F)

2. Viscosity Index: It is used to grade lubricants. Viscosity is inversely proportional to temp.

-If temp. increases, the viscosity of the lubricant decreases and if temp. decreases, the viscosity of the lubricant increases.

-The variation of viscosity of oil with changes in temperature is measured by viscosity index

-oil to measure is compared with 2 reference oil having same viscosity at 99°C . one is paraffinic base oil index of zero and another naphthenic base oil index of 100

-high viscosity index number indicates relatively smaller change in viscosity of the oil with temperature.

-low viscos oil is recommended for automobile engines in winter than summer. The viscosity of a lubricant should be just sufficient to ensure lubrication. If it is more than this value, power loss will be higher due to increased oil resistance.

-VI improver are added to improve viscosity index

3. Oiliness: It is the property of a lubricating oil to spread & attach itself firmly to the bearing surfaces as well as provide lubricity. Generally, the oiliness of the lubricating oil should be high particularly when it is to be used for mating surfaces subjected to a high intensity of pressure and smaller clearance portion to avoid the squeezing out of the oil. Such a way that the metal is protected by a thin layer of the oil and the wear is also considerably reduced. It is measured by co-efficient of friction at extreme operating condition.

4. Flash Point: Flash point of oil is the min. temp. at which the vapours of lubricating oil will flash when a small flame is passed across its surface. It is of two type open flash point and closed flash point. The flash point of the lubricating oil must be higher than the temp. likely to be developed in the bearings in order to avoid the possibility of fire hazards.

5. Fire Point: If the lubricating oil is further heated after the flash point has been reached, the lowest temp. at which the oil will burn continuously for 5 seconds is called fire point.

-usually 11°C higher than open flash point and varies from 190°C to 290°C for the lubricants used for IC engines

-The fire point of a lubricant also must be high so that the oil does not burn in service.

6. Cloud Point: It is the temp. at which the lubricating oil changes its state from liquid to solid. Its temp. must high for the low temp. operability of the lubricating oil during winter.

7. Pour Point: It is the lowest temp. at which the lubricating oil will not flow or totally form wax or solidify. This property must be considered because of its effect on starting an engine in cold weather. Oil derived from paraffinic crudes tends to have higher pour points than those derived from naphthenic crudes. The pour points can be lower by the addition of pour point depressant usually a polymerised phenol or ester. Pour point must be at least 15°F lower than the operating temperature to ensure maximum circulation.

8. Corrosiveness: The present of acid (mineral acid, petroleum acid) is harmful to the metal surfaces. The lubrication oil should not attack chemically the materials of the engine. The lubricant should not be corrosive, but it should give protection against corrosion. New oil has low neutralisation number i.e. it maintains the alkaline and acid solution to make the oil neutral.

9. Oxidation stability: It is resistance to oxidation. Due to oxidation the oil will form deposits on the piston rings and lose its lubricating property. Low temperature operation avoiding the hot-area contact and crankcase ventilation can help in preserving the stability of oil over longer periods. Oxidation inhibitors are used to improve oxidation stability. These are complex compounds of sulphur and phosphorus or amine and phenol derivatives.

10. Cleanliness: Lubricating oil must be clean. It should not contain dust and dirt particles as well as water content which promote corrosion.

11. Carbon residue: after evaporation of a mass sample of lubricating oil under specific condition may remain as carbonaceous residue. It indicates the deposit characteristics of oil. Paraffinic oil has higher carbon residues than the naphthenic base oil.

Types of lubricants:

Lubricants are at following three types.

1. Solid: graphic, mica etc
2. Semi solid: grease
3. Liquid: Lubricants are obtained from animal fat, vegetables and minerals. Lubricants made of animal fat, does not stand much heat. It becomes waxy and gummy which is not very suitable for machines. Vegetable lubricants are obtained from seeds, fruits and plants. Cottonseed oil, olive oil, linseed oil and castor oil are used as lubricant in small machines. Mineral lubricants are most popular for engines and machines. It is obtained from crude petroleum found in nature. Petroleum lubricants are less expensive and suitable for internal combustion engines.

-Graphite is often mixed with oil to lubricate automobile spring. Graphite is also used as a cylinder lubricant.

-Grease is used for chassis lubrication.

Grade of lubricants: Generally lubricating oils are graded by SAE (society of automotive engineers) method by assign a number to oil whose viscosity at given temperatures falls in certain range.

-Two temperatures -18°C (0°F) and 99°C (210°F) are used to assign the number

ex-*Single grade type:* (a) SAE 5w,10w and 20w grades are viscosity at -18°C (0°F) and for

winter use.

(b) SAE 20, 30, 40 and 50 grades lubricating oil are viscosity at 99°C (210°F) and for summer use.

Multi-grade type: ex- SAE 20W/50 oil has viscosity equal to that at SAE 20W at -18°C and viscosity equal to that at SAE 50 at 99°C

SAE grades of oil are based on viscosity but not quality based. API (American petroleum institute) used regular, premium and heavy duty type oil which are based upon properties of oil and operating conditions. Generally regular type oil is straight mineral oil, premium type contained oxidation inhibitors and heavy type contained oxidation inhibitors plus detergent-dispersant additives.

According to API,

For gasoline engine 5 service ratings oil are used: SA, SB, SC, SD and SE

For diesel engines 4 service ratings are use: CA, CB, CC and CD

Where S and C stands for SI and CI engines

Rating A is for light-duty service, the severity of service increasing towards rating D and E which is severe duty.

Lubrication system: various lubrication system used for IC engines are,

- (a) Mist lubrication system
- (b) Wet sump lubrication system
- (c) Dry sump lubrication system

(a) Mist lubrication system:

-Used where crankcase lubrication is not suitable

- Generally adopted in two stroke petrol engine line scooter and motor cycle. It is the simplest form of lubricating system.

- It is the simplest form of lubricating system. It does not consist of any separate part like oil pump for the purpose of lubrication.

- In this system the lubricating oil is mixed into the fuel (petrol) while filling in the petrol tank of the vehicle in a specified ratio (ratio of fuel and lubricating oil is from 12:1 to 50:10 as per manufacturers specifications or recommendations.

- When the fuel goes into the crank chamber during the engine operation, the oil particles go deep into the bearing surfaces due to gravity and lubricate then. The piston rings, cylinder walls, piston pin etc. are lubricated in the same way.

-If the engine is allowed to remain unused for a considerable time, the lubricating oil separates oil from petrol & leads to clogging (blocking) of passages in the carburettor, results in the engine starting trouble. This is the main disadvantage of this system.

-It causes heavy exhaust smoke due to burning of lubricating oil partially or fully

-Increase deposits on piston crown and exhaust ports which affect engine efficiency

-Corrosion of bearing surfaces due to acids formation

-thorough mixing can fetch effective lubrication

-Engine suffers insufficient lubrication during closed throttle i.e. vehicle moving down the hill.

(b) Wet sump lubrication system:

Bottom of the crankcase contains oil pan or sump from which the lubricating oil is pumped to various engine components by a pump. After lubrication, oil flows back to the sump by gravity. Three types of wet sump lubrication system,

- (i) Splash system
- (ii) Splash and pressure system
- (iii) Pressure feed system

(i) Splash system:

-In this system of lubrication the lubricating oil is stored in an oil sump. A scoop or dipper is made in the lower part of the connecting rod. When the engine runs, the dipper dips in the oil once in every revolution of the crank shaft, the oil is splashed on the cylinder wall. Due to this action engine walls, piston ring, crank shaft bearings are lubricated.

-It is used for light duty engine

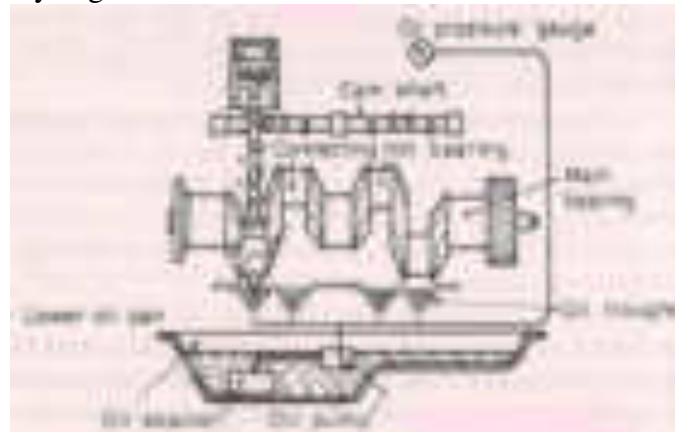

Fig. 40. Splash lubricating system

(ii) Splash and pressure system:

Lubricating oil is supplied under pressure to main, camshaft bearings and pipes which direct a stream of oil against the dippers on the big end of connecting rod bearing cup and thus crankpin bearings are lubricated by the splash or spray of oil thrown up by the dipper.

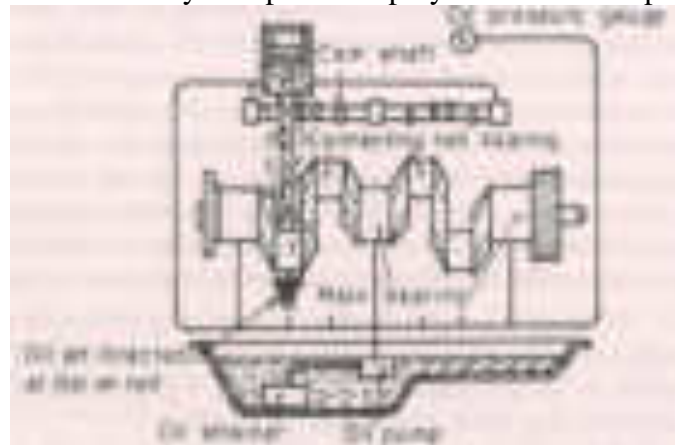

Fig. 41. Splash and pressure lubricating system

(iii) Pressure feed system:

In this system of lubrication, the engine parts are lubricated under pressure feed. The lubricating oil is stored in a separate tank (in case of dry sump system) or in the sump (in case of wet sump system), from where an oil pump (gear pump) delivers the oil to the main oil gallery at a pressure of 2-4 kg/cm² through an oil filter. The oil from the main gallery goes to main bearing, from where some of it falls back to the sump after lubricating the main bearing and some is splashed to lubricate the cylinder walls and remaining goes through a hole to the

crank pin. From the crank pin the lubricating oil goes to the piston pin through a hole in the connecting rod, where it lubricates the piston rings. For lubricating cam shaft and gears the oil is led through a separate oil line from the oil gallery. The oil pressure gauge used in the system indicates the oil pressure in the system. Oil filter & strainer in the system clear off the oil from dust, metal particles and other harmful particles.

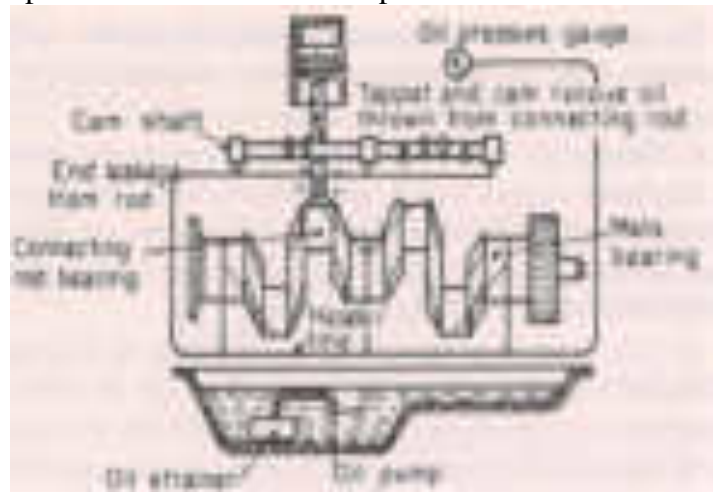

Fig. 42. Pressure lubricating system

Gear system:

- Used for a medium sized diesel engine
- It is a forced-feed system of lubrication and uses the oil contained in the bed plate as a reservoir. A gear type oil pump is driven from the crankshaft.
- The oil enters the pump and is carried around the pump casing by the gear teeth. It is then discharged. The oil is prevented from returning to the inlet by the meshing of the gear teeth. Oil is pumped from the bed plate through an oil filter and cooler into the lubricating oil manifold. A separate pipe supplies oil to the turbocharger. A supply of cooled oil is critical for the turbocharger to lubricate the high-speed bearings and to carry heat away from the rotor.

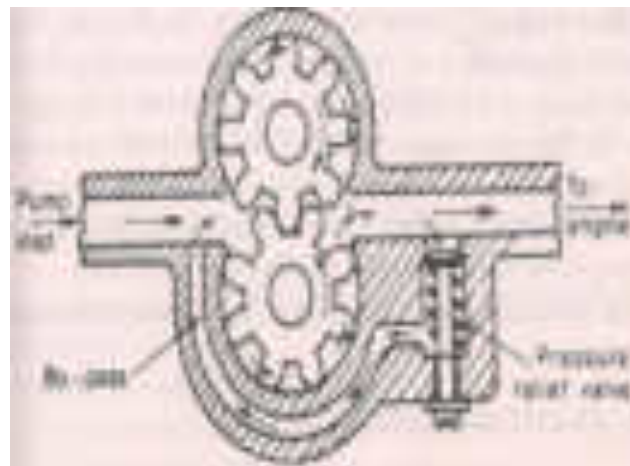

Fig. 43. Gear type lubrication system

(c) Dry sump lubrication system:

- Supply of oil is carried in external tank
- Oil pump draws oil from the supply tank and circulates it under pressure to various bearings of the engine

- Oil dripping from the cylinders and bearings into the sump is removed by a scavenging pump and again return to supply tank through the filter
- The capacity of scavenging pump is greater than the oil pump
- Separate oil cooler to remove heat from oil is used which is either cooled by air or water

Module-IV

GAS TURBINES

Two types of gas turbine,

- (a) Open cycle gas turbine
- (b) Closed cycle gas turbine

(a) Open cycle gas turbine:

- Working on Joule cycle or Brayton cycle
- Air is compressed in a rotary compressor and passed into a combustion chamber where fuel is burnt, the products of combustion are made to impinge over rings of turbine blades with high velocity and work is produced. After the work done by the combustion products, rest are given to the atmosphere.
- 60% of work produced is used to drive the compressor and rest is available as useful power
- For starting purpose, it is first motored to minimum speed, called coming in speed, before the fuel is turned on
- About 5% power output by the motor is used to start the turbine

To improve the turbine performance intercooler, heat exchanger and reheat cycles are used with simple gas turbine cycle.

(b) Closed cycle gas turbine:

- Working fluid air or other gas is circulated continuously inside the machine
- Working fluid does not come in contact with the atmospheric air or fuel
- Heat to working fluid is given externally by the burning of the fuel that is why it is external combustion engine
- Turbine exhaust rejects heat in a cooler

Advantage of closed cycle gas turbine:

- Due to externally fired, cheaper fuel such as coal can be used
- Products of combustion is not in directly contact with turbine blades, hence fouling and heat transfer from the surface of the blade can be avoided
- Part load efficiency is improved by changing the pressure ratio and varying the quantity of working fluid keeping as cycle temperature constant and at constant speed
- High operating pressure causes low specific volume for the working fluid reducing the size of machines, heat exchangers and piping
- Heat transfer coefficients are higher which reduces the heat exchanger size

Disadvantage of closed cycle gas turbine:

- more complicated and costly system
- Air heaters alone represent over 30% of total mass and cost
- system is not sufficiently strong to resist high pressure

***Simple Gas turbine:**

Following assumptions are made in analysis of ideal gas turbine,

- Compression and expansion process are reversible adiabatic
- Kinetic energy does not change at the inlet and exit
- No pressure loss
- Same chemical composition of working fluid
- Heat exchanger is counter flow type with 100% efficiency

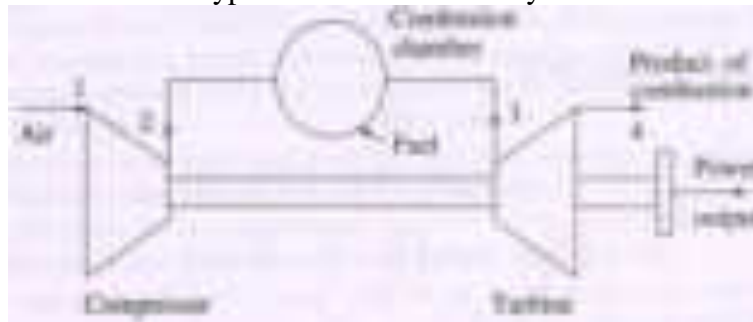
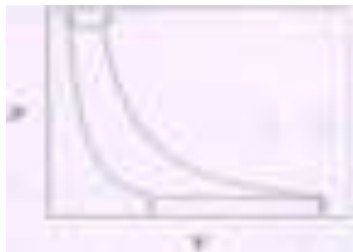

Fig. 44. Simple gas turbine



P-V diagram



T-S diagram

Compressor work,

$$W_c = h_2 - h_1 = C_p(T_2 - T_1)$$

Heat addition,

$$Q_{23} = h_3 - h_2 = C_p(T_3 - T_2)$$

Turbine work,

$$W_T = h_3 - h_4 = C_p(T_3 - T_4)$$

Net work output, $W_N = W_T - W_c$

$$W_N = C_p T_1 \left(\frac{T_3}{T_1} - \frac{T_4}{T_1} - \frac{T_2}{T_1} + 1 \right)$$

$$\text{Let, } \frac{T_3}{T_1} = t \text{ and } \frac{p_2}{p_1} = r$$

$$\text{Then, } \frac{T_2}{T_1} = \frac{T_3}{T_4} = r^{\frac{\gamma-1}{\gamma}} = c$$

Net work,

$$\frac{W_N}{C_p T_1} = t \left(1 - \frac{1}{c} \right) - (c - 1)$$

$$\text{Efficiency, } \eta = \frac{\text{Net work output}}{\text{Heat input}} = \frac{W_N}{Q} = 1 - \frac{1}{c}$$

Efficiency depends upon the pressure ratio and nature of the gas.

For maximum work out put,

$$r^{\frac{\gamma-1}{\gamma}}_{opt} = \sqrt{t}$$

i.e. the specific work out is maximum when the pressure ratio is such that the compressor and turbine inlet temperature are equal.

***Heat exchange cycle:**

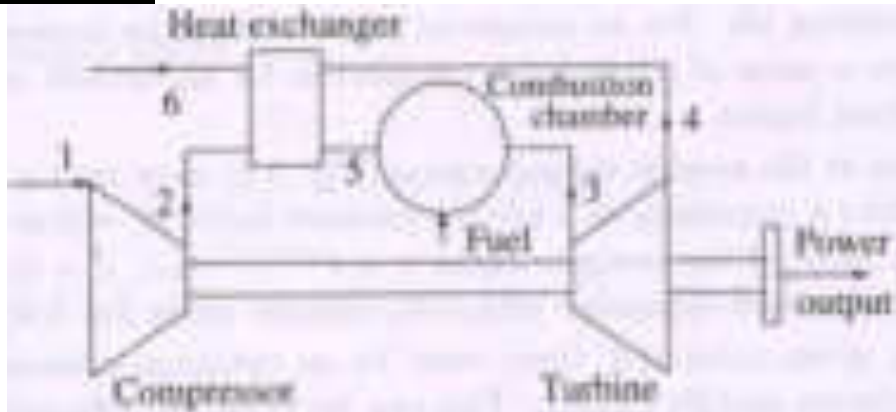
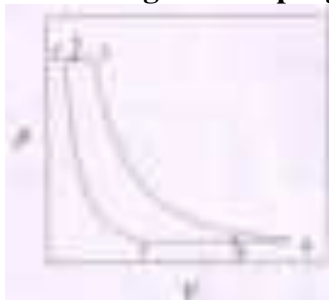

Fig. 45. Simple gas turbine with heat exchanger



P-V diagram



T-S diagram

Heat addition,

$$Q_{53} = h_3 - h_5 = C_p(T_3 - T_5)$$

Specific work out put,

$$\frac{W_N}{C_p T_1} = t \left(1 - \frac{1}{c} \right) - (c - 1)$$

Efficiency,

$$\eta = \frac{\text{Net work output}}{\text{Heat input}} = \frac{W_N}{Q} = 1 - \frac{c}{t}$$

Efficiency increases with increase in t i.e. it is dependent upon maximum cycle temperature.

Efficiency increases with decrease in pressure ratio.

***Reheat cycle:**

Increases specific work out put but the efficiency is decreased.

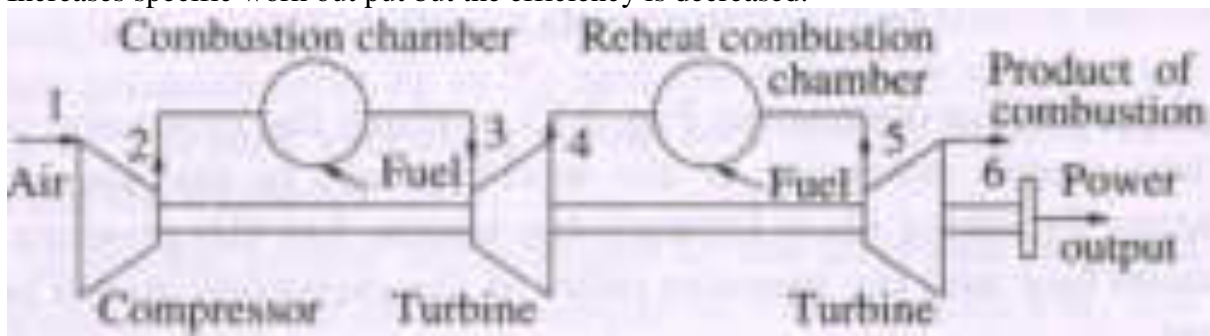
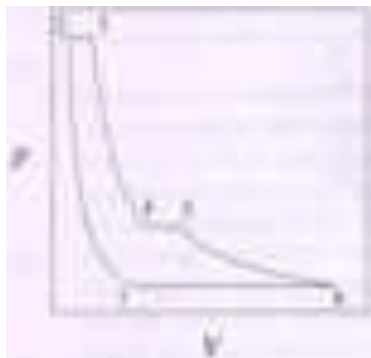
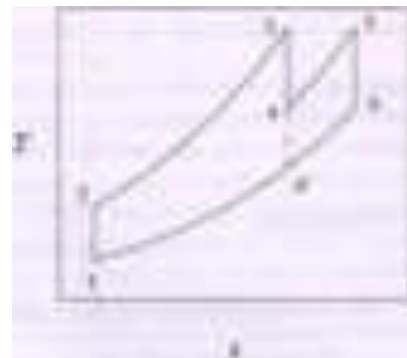

Fig. 46. Arrangement of reheat cycle



P-V diagram



T-S diagram

Heat addition,

$$Q_{23} = h_3 - h_2 = C_p(T_3 - T_2)$$

$$Q_{45} = h_5 - h_4 = C_p(T_5 - T_4)$$

Turbine work,

$$W_{34} = h_3 - h_4 = C_p(T_3 - T_4)$$

$$W_{56} = h_5 - h_6 = C_p(T_5 - T_6)$$

Assume that,

$$r = r_3 \times r_4$$

$$c = r^{\frac{\gamma-1}{\gamma}} = \frac{T_2}{T_1}$$

$$c_3 = r_3^{\frac{\gamma-1}{\gamma}} = \frac{T_3}{T_4}$$

$$c_4 = r_4^{\frac{\gamma-1}{\gamma}} = \frac{T_5}{T_6}$$

$$c = c_3 \times c_4$$

$$T_5 = T_3$$

Specific work out put,

$$\frac{W_N}{C_p T_1} = 2t - \frac{t}{c_3} - \frac{t}{c_4} - c + 1$$

For maximum specific work out put,

$$c_3 = \sqrt{c} = c_4$$

i.e. to obtain maximum specific output stage pressure ratio must be same and equal to square root of overall pressure ratio for two stage expansion.

Then,

$$\frac{W_{max}}{C_p T_1} = 2t \left(1 - \frac{1}{\sqrt{c}} \right) - (c - 1)$$

$$\eta_{max} = \frac{2t \left(1 - \frac{1}{\sqrt{c}} \right) - (c - 1)}{2t - c - \frac{t}{\sqrt{c}}}$$

Efficiency is less due to small temperature operating range.

***Reheat and Heat exchange cycle:**

Specific power output is increased in reheat cycle in the expense of the efficiency and it can be overcome by adding a heat exchanger to reheat cycle.

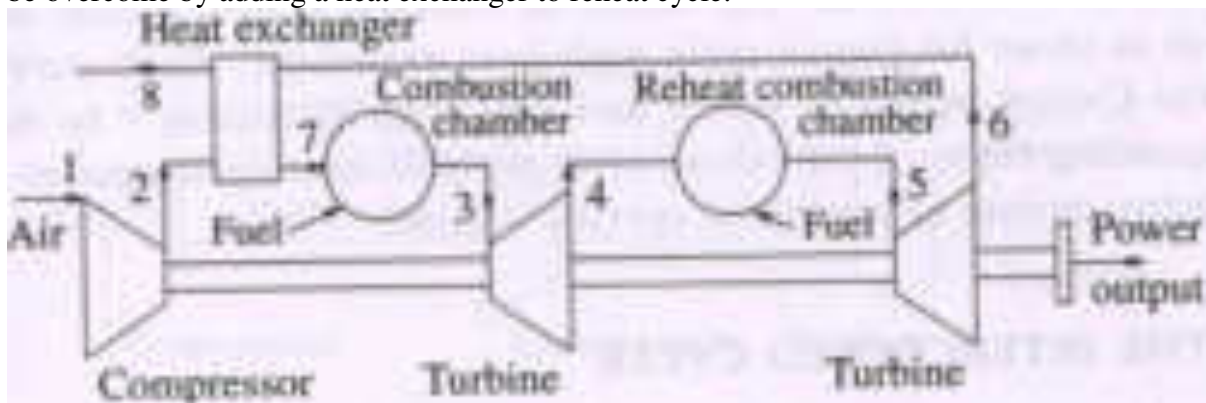
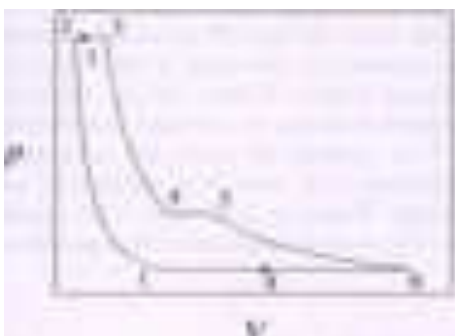

Fig. 47. Arrangement of reheat cycle with heat exchanger



P-V diagram



T-S diagram

Heat addition,

$$Q_{73} + Q_{45} = C_p(T_3 - T_7) + C_p(T_5 - T_4)$$

Turbine work,

$$W_{34} + W_{56} = C_p(T_3 - T_4) + C_p(T_5 - T_6)$$

Maximum specific work output is same with reheat cycle, i.e.,

$$\frac{W_{max}}{C_p T_1} = 2t \left(1 - \frac{1}{\sqrt{c}} \right) - (c - 1)$$

But maximum efficiency will change due to heat exchanger,

$$\eta_{max} = \frac{C_p T_1 [2t \left(1 - \frac{1}{\sqrt{c}} \right) - (c - 1)]}{C_p (T_3 - T_7) + C_p (T_5 - T_4)}$$

$$= \frac{C_p T_1 \left[2t \left(1 - \frac{1}{\sqrt{c}} \right) - (c - 1) \right]}{\frac{T_3}{T_1} - \frac{T_7}{T_1} + \frac{T_5}{T_1} - \frac{T_4}{T_1}}$$

Since, $T_7 = T_4$ and $T_5 = T_3$,

$$\eta_{max} = 1 - \frac{c - 1}{2t - \frac{2t}{\sqrt{c}}}$$

***Intercooled cycle:**

Another way of increasing the specific work output of gas turbine is reducing the work of compression i.e. compression in more than one stage and using an intercooler in between the compressor.

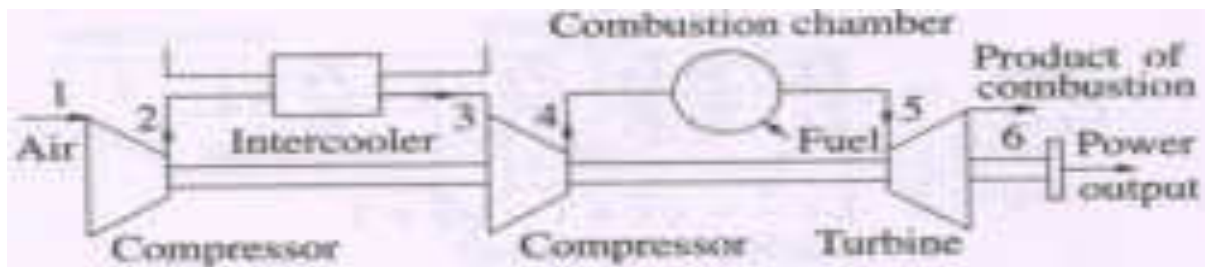
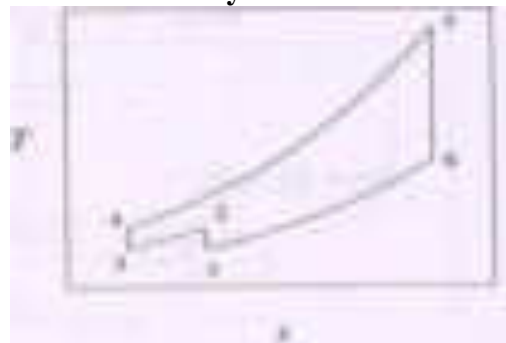

Fig. 48. Arrangement of intercooled cycle



P-V diagram



T-S diagram

Compressor work,

$$W_{12} + W_{34} = C_p (T_2 - T_1) + C_p (T_4 - T_3)$$

Heat addition,

$$Q_{45} = h_5 - h_4 = C_p (T_5 - T_4)$$

Turbine work,

$$W_{78} + W_{56} = C_p(T_7 - T_8) + C_p(T_5 - T_6)$$

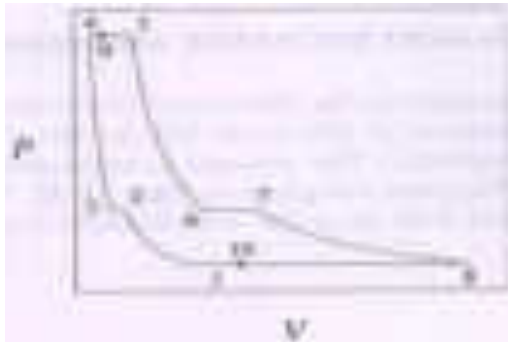

P-V diagram

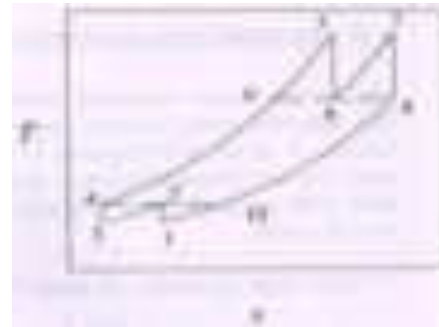

T-S diagram

Maximum specific work out put,

$$\frac{W_{max}}{C_p T_1} = 2 \left(t - \frac{t}{\sqrt{c}} - \sqrt{c} + 1 \right)$$

Here, $T_6 = T_8$

$$\eta_{max} = 1 - \frac{\sqrt{c}}{t}$$

***Practical cycle:**

Assumptions,

- Fluid velocities are high in turbo-machinery, the change in K.E. change is considered
- compression and adiabatic process are irreversible adiabatic process
- pressure loss in combustion chamber
- complete heat exchange is not possible
- more work required for compression
- C_p and γ values of working fluid change with temperature

Compressor and turbine efficiency:

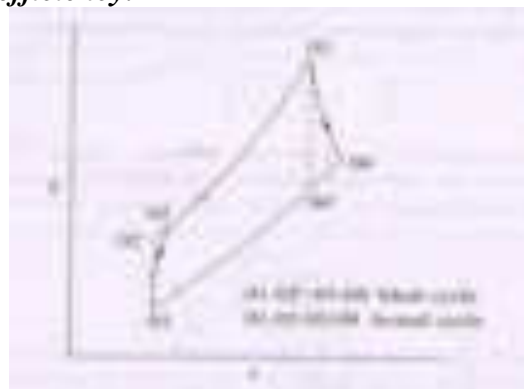

Fig. 50. T-S diagram of actual cycle

During compression considerable amount of energy supplied to the compressor is wasted in churning of the working fluid. This energy does not contribute to the pressure rise but is converted into heat by friction.

Compressor efficiency is,

$$\eta_c = \frac{h_{02'} - h_{01}}{h_{02} - h_{01}} = \frac{T_{02'} - T_{01}}{T_{02} - T_{01}}$$

Let, total head pressure ratio or stagnation pressure ratio in the compressor = r_c

$$\frac{T_{02'}}{T_{01}} = r_c^{(\gamma-1)/\gamma}$$

$$\text{Then, } T_{02} - T_{01} = \frac{T_{01}}{\eta_c} [r_c^{(\gamma-1)/\gamma} - 1]$$

$$W_{cact} = \frac{C_p T_{01}}{\eta_c} [r_c^{(\gamma-1)/\gamma} - 1]$$

Turbine efficiency is,

$$\eta_T = \frac{h_{03} - h_{04}}{h_{03} - h_{04'}} = \frac{T_{03} - T_{04}}{T_{03} - T_{04'}}$$

Let, r_t = total head pressure ratio in expansion process

$$\frac{T_{03}}{T_{04'}} = r_t^{(\gamma-1)/\gamma}$$

$$T_{03} - T_{04} = \eta_T T_{03} \left[1 - \frac{1}{r_t^{(\gamma-1)/\gamma}} \right]$$

$$W_{tact} = C_p \eta_T T_{03} \left[1 - \frac{1}{r_t^{(\gamma-1)/\gamma}} \right]$$

Net work done,

$$W_N = W_{tact} - W_{cact} = C_p \eta_T T_{03} \left[1 - \frac{1}{r_t^{(\gamma-1)/\gamma}} \right] - \frac{C_p T_{01}}{\eta_c} [r_c^{(\gamma-1)/\gamma} - 1]$$

$$\text{Work ratio} = \frac{W_N}{W_{tact}} = 1 - \frac{C_p \eta_T T_{03} \left[1 - \frac{1}{r_t^{(\gamma-1)/\gamma}} \right] - \frac{C_p T_{01}}{\eta_c} [r_c^{(\gamma-1)/\gamma} - 1]}{C_p \eta_T T_{03} \left[1 - \frac{1}{r_t^{(\gamma-1)/\gamma}} \right]}$$

If $r_c = r_t = r$,

$$\text{Work ratio} = 1 - \frac{T_{01} [r^{(\gamma-1)/\gamma} - 1]}{\eta_c \eta_T T_{03}} = 1 - \frac{c}{t} \frac{1}{\eta_c \eta_T}$$

Where, $c = r^{(\gamma-1)/\gamma}$ and $t = \frac{T_{03}}{T_{01}}$

Work ratio is increased by high temperature ratio t and low pressure ratio, r .

***Gas turbine combustion chamber:**

2 types of combustion chambers,

(a) Tubular or Can chambers: cylindrical liner is mounted concentrically inside cylindrical casing

-mostly used in jet engines

-with this centrifugal compressor is used

(b) Annular chambers: annular liner is mounted concentrically inside annular casing

-difficult to maintain for air and fuel flow and maintain stable temp.

***Automotive gas turbines:**

- First gas turbine car is JET1 with speed record of 243 km/h
- Then car with heat exchanger was developed to attain speed of 163 km/h and also Rover BPM-car was introduced

Advantage of automotive gas turbines;

- thermodynamic advantage of complete expansion
- Mechanical simplicity i.e. fewer moving parts compared to reciprocating IC engine
- Smooth and vibration less power delivery
- Specific weight is 10-20% less than SI engine
- Low emissions
- Easy cold starting
- High mechanical efficiency of 85-90%
- Cheaper fuels are used

Disadvantage of automotive gas turbines;

- Lower thermal efficiency due to lower temperatures and compressor efficiency than reciprocating IC engine
- Part load efficiency is very poor
- Difficulties in throttle operation due to high rotor speed
- High initial cost

***Arrangements of automotive gas turbines:**

(a) Single shaft configuration: single expander turbine to drive both compressor and drive train on a common engine shaft

- less weight, low cost and better efficiency
- incapable of meeting highly variable operating conditions

(b) Twin shaft configuration:

- Turbo-compressor is mounted on one shaft and power turbine is mounted on another second shaft which provides power to the wheels via transmission

Text book:

1. Internal Combustion Engine – M.L. Mathur and R.P. Sharma, Dhanpat Rai Publications.
2. A Text book of Internal Combustion Engines – R.K. Rajput, Laxmi Publication (P) Ltd.
3. Gas Turbines – V.Ganesan, TMH publication.

References and Web resources:

1. Ignition system, <http://www.ignou.ac.in/upload/unit%204.pdf>
2. Cooling system, http://www.iitg.ernet.in/scifac/qip/public_html/cd_cell/chapters/uk_saha_internal_combustion_engine/qip-ice-25-cooling%20systems.pdf
3. <http://hillagric.ac.in/edu/coa/agengg/lecture/243/Lecture%207%20Cooling%20and%20lubrication.pdf>
4. lubrication system,
http://www.iitg.ernet.in/scifac/qip/public_html/cd_cell/chapters/uk_saha_internal_combustion_engine/qip-ice-23-lubrication%20systems.pdf
5. <http://144.162.92.233/faculty/mwhitten/presentations/1306/lubricationsystem.pdf>
6. <http://scienceandtechnicalprojects.blogspot.in/2007/12/lubrication-system-of-ic-engine.html>